



## Miniature FRL Series

**14F Filters - Miniature**

**Features**

- Excellent water removal efficiency.
- Unique deflector plate that creates swirling of the air stream ensuring maximum water and dirt separation.
- 5 micron element standard.
- High Flow: 1/8" – 10 dm<sup>3</sup>/s  
1/4" – 11 dm<sup>3</sup>/s

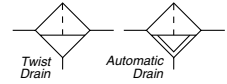
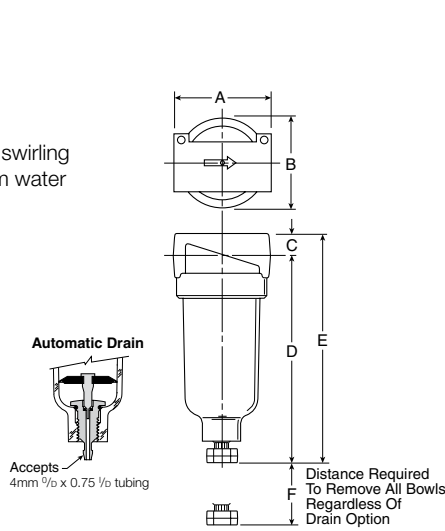

Port Size	BSPP	
	Twist Drain	Automatic Pulse Drain
<b>Poly Bowl</b>		
1/8"	<b>14F01BB1</b>	<b>14F05BB1</b>
1/4"	<b>14F11BB1</b>	<b>14F15BB1</b>

14F Filter Dimensions (mm)		
A 43	B 39	C 10
D 97	D† 99	E 107
E† 108	F 41	

Standard part numbers shown.

For other models refer to ordering information below.

§ dm<sup>3</sup>/s = 6.2 bar inlet and 0.3 bar pressure drop.

† With Automatic Pulse Drain.

**Ordering Information**

**1 4 F 1 1 B B 1**

	<b>Port size</b>	<b>Bowl options</b>	<b>Elements</b>	<b>Port type</b>
0	1/8 Inch	1	B	Blank
1	1/4 Inch	5	5 Micron	1
		<b>Twist drain</b>		<b>BSPP</b>
		<b>Automatic pulse drain</b>		

**NOTE: BOLD OPTIONS ARE STANDARD.**

**Technical Information**

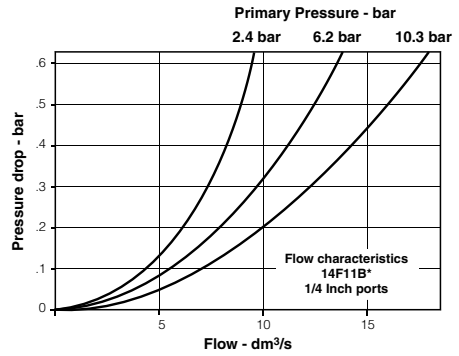
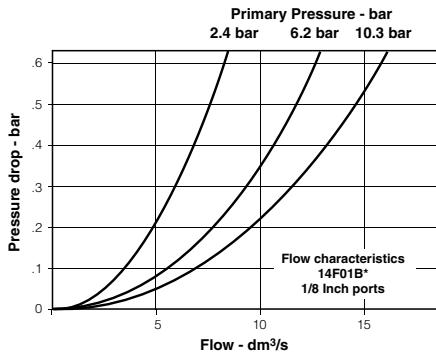

**14F Filter Kits & Accessories**

**Bowl Kits –**

**Poly Bowl –**

- Automatic Pulse Drain ..... PS408P
- Twist Drain..... PS404P

**Filter Element Kits –**

- 5 Micron ..... PS403P

- Mounting Bracket Kit** ..... PS417BP

**Specifications**

**Automatic Pulse Drain Tube Barb** ..... 4mm<sup>OD</sup> x 0.75 1/8

**Bowl Capacity** ..... 30 cm<sup>3</sup>

**Port Threads** ..... 1/8, 1/4 Inch

**Pressure & Temperature Ratings –**

Polycarbonate Bowl..... 0 to 10.3 bar  
 0°C to 52°C

Automatic Pulse Drain ..... 0.7 to 10.3 bar  
 at 52°C or less

**Weight** ..... 180 g

**Materials of Construction**

**Body**..... Zinc Bowl Transparent Polycarbonate

**Deflector, Element Holder & Baffle** ..... Plastic

**Drains –**

**Twist Drain –**

Body & Stem ..... Plastic

Seals ..... Nitrile

**Automatic Pulse Drain –**

Piston & Seals ..... Nitrile

Stem, Seat, Adaptor & Washers ..... Aluminum

**Filter Elements –**

5 Micron (Standard) ..... Plastic

**Seals** ..... Nitrile

**10F Coalescing Filters - Miniature**

**Features**

- Removes liquid aerosols and sub-micron particles.
- Liquids gravitate to the bottom of the element and will not re-enter the airstream.
- Oil free air for critical applications, such as air gauging and pneumatic instrumentation and controls.
- 99.97% DOP efficiency.
- High Flow: Grade 6 Element
  - 1/8" – 8 dm<sup>3</sup>/s
  - 1/4" – 9 dm<sup>3</sup>/s

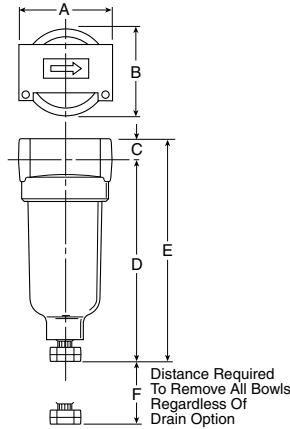
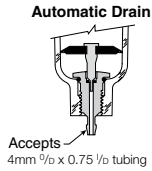

Port Size	BSPP	
	Twist Drain	Automatic Pulse Drain
<b>Poly Bowl</b>		
1/8"	<b>10F01ED1</b>	<b>10F05ED1</b>
1/4"	<b>10F11ED1</b>	<b>10F15ED1</b>

Standard part numbers shown.

§ dm<sup>3</sup>/s = 6.2 bar inlet and 0.3 bar pressure drop.

10F Coalescing Filter Dimensions (mm)		
A	B	C
43	39,6	10
D	D <sup>†</sup>	E
97	93	107
E <sup>†</sup>	F	
103	41	

<sup>†</sup> With Automatic Pulse Drain.

**Ordering Information**

1
0
F
 
1
1
E
D
-

	Port size
0	1/8 Inch
1	1/4 Inch

	Bowl options
1	Twist drain
5	Automatic pulse drain

	Elements
E	0.01 um

	Port type
Blank	NPT
1	BSPP

**NOTE: BOLD OPTIONS ARE STANDARD.**

**Technical Information**

**Grade 6**

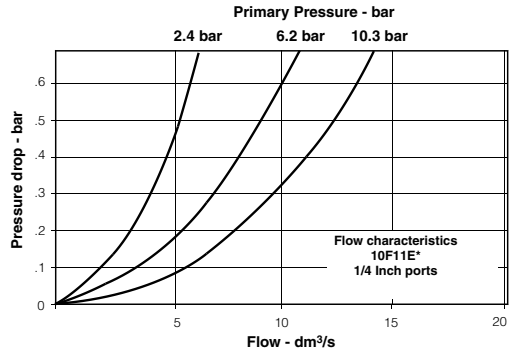
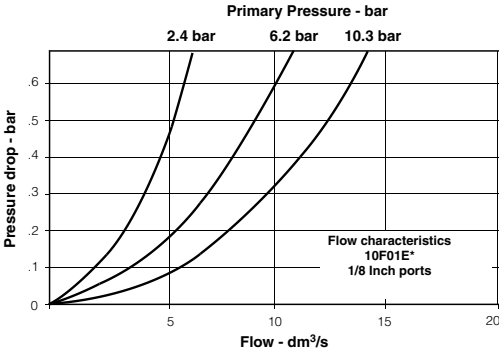

**10F Coalescing Filter Kits & Accessories**

- Bowl Kits –**
- Poly Bowl** –Automatic Pulse Drain ..... PS408P
- Twist Drain ..... PS404P
- Filter Element Kits** – 0.01 µm ..... PS446P
- Mounting Bracket Kit** ..... PS417BP

**Specifications**

- Automatic Pulse Drain Tube Barb** ..... 4mm<sup>o</sup>/<sub>b</sub> x 0.75 <sup>1</sup>/<sub>b</sub>
- Bowl Capacity** .....30cm<sup>3</sup>
- Operation –**
- Normal Operating Pressure Drop ..... 0.1 bar
- Maximum Recommended Pressure Drop ..... 0.7 bar  
(Element should be replaced)
- Port Threads** ..... 1/8, 1/4 Inch
- Pressure & Temperature Ratings –**
- Polycarbonate Bowl – ..... 0 to 10.3 bar  
0°C to 52°C
- Weight** ..... 180 g

**Materials of Construction**

- Body** .....Zinc
- Bowls** .....Transparent Polycarbonate
- Drains – Twist Drain –**
- Body & Stem..... Plastic
- Seals..... Nitrile
- Automatic Pulse Drain –
- Piston & Seals .....Nitrile
- Stem, Seat, Adaptor & Washers ..... Aluminum
- Element Holder** ..... Plastic
- Filter Element –**
- Borosilicate & felt glass fibers 99.97% DOP efficiency
- Seals** .....Nitrile

**14R Regulators - Miniature**

**Features**

- Unbalanced poppet standard.
- Solid control piston with lip seal for extended life.
- Non-rising adjusting knob.
- Compact, 73,2mm high by 42mm wide.
- High Flow: 1/8" – 6 dm<sup>3</sup>/s  
1/4" – 7 dm<sup>3</sup>/s

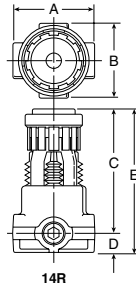
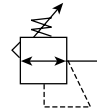

Port Size	8 bar - BSP
Without Gauge	
1/8"	<b>14R013FC1</b>
1/4"	<b>14R113FC1</b>

14R Regulator Dimensions (mm)					
14R	A	B	C	D	E
	42	40	63,5	10	73

Standard part numbers shown bold. For other models refer to ordering information below.

NOTE: 31mm dia. hole required for panel mounting.

§ dm<sup>3</sup>/s = 6.9 bar inlet, 6.2 bar no flow secondary setting and 0.7 bar pressure drop.

**Ordering Information**

**1 4 R 1 13 F C 1**

<table border="1" style="width: 100%; border-collapse: collapse;"> <tr> <th style="width: 10%;"></th> <th>Port size</th> </tr> <tr> <td style="text-align: center;">0</td> <td><b>Port size 1/8 Inch pipe 1/8 Inch gauge port</b></td> </tr> <tr> <td style="text-align: center;">1</td> <td><b>1/4 Inch pipe 1/8 Inch gauge port</b></td> </tr> </table>		Port size	0	<b>Port size 1/8 Inch pipe 1/8 Inch gauge port</b>	1	<b>1/4 Inch pipe 1/8 Inch gauge port</b>	<table border="1" style="width: 100%; border-collapse: collapse;"> <tr> <th style="width: 10%;"></th> <th>Pressure range</th> </tr> <tr> <td colspan="2">Without gauge - Yellow knob</td> </tr> <tr> <td style="text-align: center;">10</td> <td>2 bar</td> </tr> <tr> <td style="text-align: center;">11</td> <td>4 bar</td> </tr> <tr> <td style="text-align: center;">13</td> <td><b>8 bar</b></td> </tr> </table>		Pressure range	Without gauge - Yellow knob		10	2 bar	11	4 bar	13	<b>8 bar</b>	<table border="1" style="width: 100%; border-collapse: collapse;"> <tr> <th style="width: 10%;"></th> <th>Relief</th> </tr> <tr> <td style="text-align: center;">F</td> <td><b>Relieving</b></td> </tr> <tr> <td style="text-align: center;">G</td> <td>Non-Relieving</td> </tr> </table>		Relief	F	<b>Relieving</b>	G	Non-Relieving	<table border="1" style="width: 100%; border-collapse: collapse;"> <tr> <th style="width: 10%;"></th> <th>Port type</th> </tr> <tr> <td colspan="2">Blank NPT</td> </tr> <tr> <td style="text-align: center;">1</td> <td><b>BSP</b></td> </tr> </table>		Port type	Blank NPT		1	<b>BSP</b>
	Port size																														
0	<b>Port size 1/8 Inch pipe 1/8 Inch gauge port</b>																														
1	<b>1/4 Inch pipe 1/8 Inch gauge port</b>																														
	Pressure range																														
Without gauge - Yellow knob																															
10	2 bar																														
11	4 bar																														
13	<b>8 bar</b>																														
	Relief																														
F	<b>Relieving</b>																														
G	Non-Relieving																														
	Port type																														
Blank NPT																															
1	<b>BSP</b>																														

**NOTE: BOLD OPTIONS ARE STANDARD.**

**Technical Information**

**Relief and Flow Characteristics  
14R013F\***

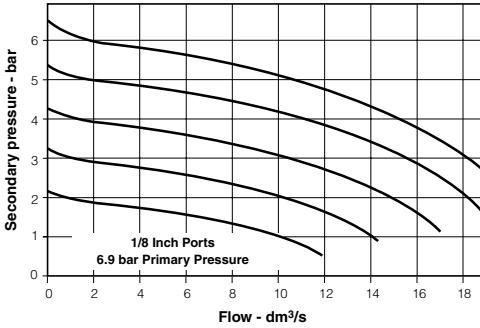

**Relief and Flow Characteristics  
14R113F\***

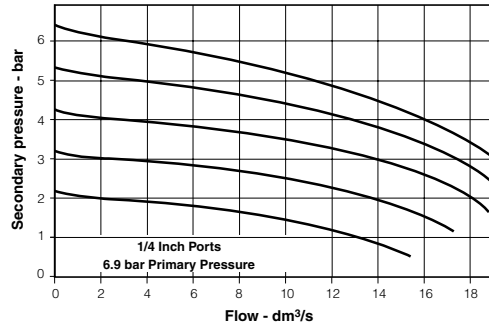

**CAUTION:**

**REGULATOR PRESSURE ADJUSTMENT** – The working range of knob adjustment is designed to permit outlet pressures within their full range. Pressure adjustment beyond this range is also possible because the knob is not a limiting device. This is a common characteristic of most industrial regulators, and limiting devices may be obtained only by special design.

For best performance, regulated pressure should always be set by increasing the pressure up to the desired setting.

**⚠ WARNING**

**Product rupture can cause serious injury.  
Do not connect regulator to bottled gas.  
Do not exceed maximum primary pressure rating.**

**14R Regulator Kits & Accessories**

- Bonnet Assembly Kit** ..... L01369
- Gauges** – 0 to 2 bar - 1/8.....P3D-KAB1AYN
- 0 to 4 bar - 1/8.....P3D-KAB1ALN
- 0 to 10 bar - 1/8.....P3D-KAB1ANN
- Mounting Bracket Kit (Includes Panel Mount Nut)** PS417BP
- Panel Mount Nuts** – Plastic.....P78652
- Metal.....P01531
- Service Kits** – Non-Relieving..... PS422P
- Relieving..... PS423P

**Specifications**

- Gauge Ports (2)** ..... 1/8
- (Can be used for Full Flow)
- Port Threads** ..... 1/8, 1/4 Inch
- Pressure & Temperature Ratings** – 0 to 20.7 bar    0°C to 52°C
- Secondary Pressure Ranges** –
- Standard Pressure..... 0 to 8 bar
- Medium Pressure ..... 0 to 4 bar
- Medium Pressure ..... 0 to 2 bar
- Weight** – 14R ..... 140 g

**Materials of Construction**

- Adjusting Nut** ..... Brass
- Adjusting Stem & Spring** ..... Steel
- Body** ..... Zinc
- Bonnet, Seat, Piston & Valve Poppet** ..... Plastic
- Seals** ..... Nitrile

**14E Filter / Regulator - Miniature**

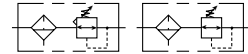

**Features**

- Excellent water removal efficiency.
- Unbalanced poppet standard.
- Solid control piston for extended life.
- Space saving package offers both filter and regulator features in one integral unit.
- Non-rising adjustment knob.
- Two full flow 1/8" gauge ports.
- High Flow: 1/8" – 7 dm<sup>3</sup>/s§  
1/4" – 8 dm<sup>3</sup>/s§

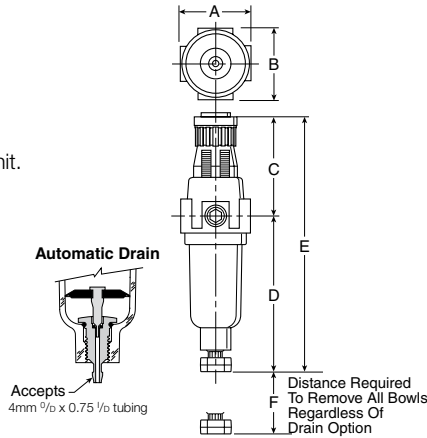

Port Size	8 BAR - BSPP	
	Twist Drain	Automatic Pulse Drain
Poly Bowl†		
1/8"	<b>14E01B13FC1</b>	<b>14E05B13FC1</b>
1/4"	<b>14E11B13FC1</b>	<b>14E15B13FC1</b>

14E Filter / Regulator Dimensions (mm)		
A 41	B 40	C 61
D 96	D† 92	E 158
E† 154	F 41	

Standard part numbers shown. For other models refer to ordering information below.

§ dm<sup>3</sup>/s = 6.9 bar inlet, 6.2 bar no flow secondary setting and 0.7 bar pressure drop.

NOTE: 31mm hole required for panel mounting.

† With Auto Drain

**Ordering Information**

**1 4 E 1 1 B 13 F C 1**

	<b>Port size</b>	<b>Bowl options</b>	<b>Elements</b>	<b>Relief</b>	<b>Port type</b>
0	1/8 Inch	1 Twist drain	B 5 Micron	F Relieving	Blank NPT
1	1/4 Inch	5 Automatic drain		G Non-Relieving	1 BSPP

Pressure range	
	Without gauge - Yellow knob
10	2 bar
11	4 bar
13	8 bar

**NOTE: BOLD OPTIONS ARE STANDARD.**



**Technical Information**

**Relief and Flow Characteristics  
14E01B13F\***

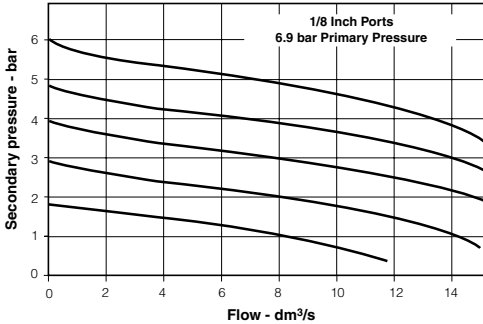

**Relief and Flow Characteristics  
14E11B13F\***

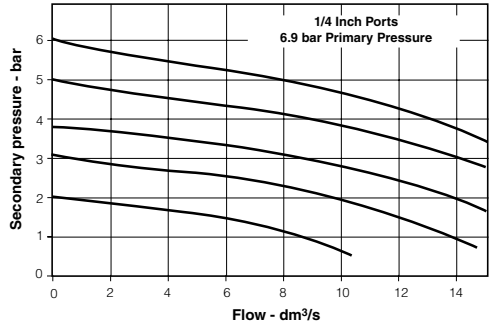

**CAUTION:**

**REGULATOR PRESSURE ADJUSTMENT** – The working range of knob adjustment is designed to permit outlet pressures within their full range. Pressure adjustment beyond this range is also possible because the knob is not a limiting device. This is a common characteristic of most industrial regulators, and limiting devices may be obtained only by special design.

For best performance, regulated pressure should always be set by increasing the pressure up to the desired setting.

**⚠ WARNING**

**Product rupture can cause serious injury.  
Do not exceed maximum primary pressure rating.**

**14E Filter / Regulator Kits & Accessories**

- Bowl Kits –**
- Poly Bowl – Automatic Drain ..... PS408P
- Twist Drain ..... PS404P
- Filter Element Kits –** 40 Micron ..... PS401P
- 5 Micron ..... PS403P
- Gauges –** 0 to 2 bar - 1/8.....P3D-KAB1AYN
- 0 to 4 bar - 1/8.....P3D-KAB1ALN
- 0 to 10 bar - 1/8.....P3D-KAB1ANN
- Mounting Bracket Kit (Includes Panel Mount Nut) ..... PS417BP**
- Panel Mount Nut ..... P78652**
- Service Kits –** Non-Relieving ..... PS422P
- Relieving ..... PS423P

**Specifications**

- Automatic Pulse Drain Tube Barb ..... 4mm<sup>O/D</sup> x 0.75<sup>l/D</sup>**
- Bowl Capacity ..... 30 cm<sup>3</sup>**
- Gauge Ports (2) (Can be used for Full Flow)..... 1/8 Inch**
- Port Threads ..... 1/8, 1/4 Inch**
- Pressure & Temperature Ratings –**
- Polycarbonate Bowl..... 0 to 10.3 bar, 0°C to 52°C
- Secondary Pressure Ranges –**
- Standard Pressure ..... 0 to 8 bar
- Medium Pressure ..... 0 to 2 bar
- Medium Pressure ..... 0 to 4 bar
- Weight ..... 180 g**

**Materials of Construction**

- Adjusting Nut ..... Brass**
- Adjusting Stem & Spring ..... Steel**
- Body..... Zinc**
- Bonnet, Knob, Seat, Piston, Holder & Deflector ..... Plastic**
- Bowl Available –** Transparent ..... Polycarbonate
- Drains –** Manual – Twist Type
- Body & Stem..... Plastic
- Seals..... Nitrile
- Automatic – Pulse Type
- Piston & Seals ..... Nitrile
- Stem, Seat, Adaptor & Washers ..... Aluminum
- Filter Elements –** 5 Micron (Standard) ..... Plastic
- Seals ..... Nitrile**

**04L Mist Lubricators - Miniature**

**Features**

- Proportional oil delivery over a wide range of air flows.
- Precision needle valve assures repeatable oil delivery and provides simple adjustment of delivery rate.
- Ideal for low and high flow applications with changing air flow.
- Transparent sight dome for 360° visibility.
- High Flow: 1/8" – 9 dm<sup>3</sup>/s§  
1/4" – 10 dm<sup>3</sup>/s§

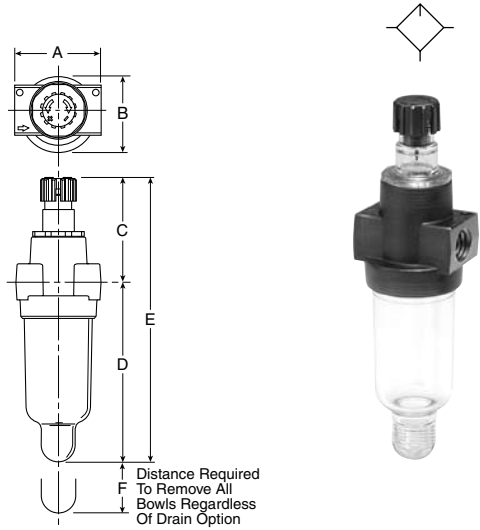

Port Size	BSPB No Drain
Poly Bowl	
1/8"	<b>04L00GB1</b>
1/4"	<b>04L10GB1</b>

04L Lubricator Dimensions (mm)		
A 44	B 40	C 55
D 92	D† 96	E 147
E† 151	F 41	

Standard part numbers shown bold.

For other models refer to ordering information below.

§ dm<sup>3</sup>/s = 6.2 bar inlet and 0.3 bar pressure drop.

**Ordering Information**

<b>0</b>	<b>4</b>	<b>L</b>	<b>1</b>	<b>0</b>	<b>G</b>	<b>B</b>	<b>-</b>														
			<table border="1" style="width: 100%; text-align: left;"> <tr> <th style="width: 20%;">Port size</th> <th></th> </tr> <tr> <td><b>0</b></td> <td><b>1/8 Inch</b></td> </tr> <tr> <td><b>1</b></td> <td><b>1/4 Inch</b></td> </tr> </table>		Port size		<b>0</b>	<b>1/8 Inch</b>	<b>1</b>	<b>1/4 Inch</b>				<table border="1" style="width: 100%; text-align: left;"> <tr> <th style="width: 20%;">Port type</th> <th></th> </tr> <tr> <td>Blank</td> <td>NPT</td> </tr> <tr> <td><b>1</b></td> <td><b>BSPB</b></td> </tr> </table>		Port type		Blank	NPT	<b>1</b>	<b>BSPB</b>
Port size																					
<b>0</b>	<b>1/8 Inch</b>																				
<b>1</b>	<b>1/4 Inch</b>																				
Port type																					
Blank	NPT																				
<b>1</b>	<b>BSPB</b>																				

**NOTE: BOLD OPTIONS ARE STANDARD.**

**Technical Information**

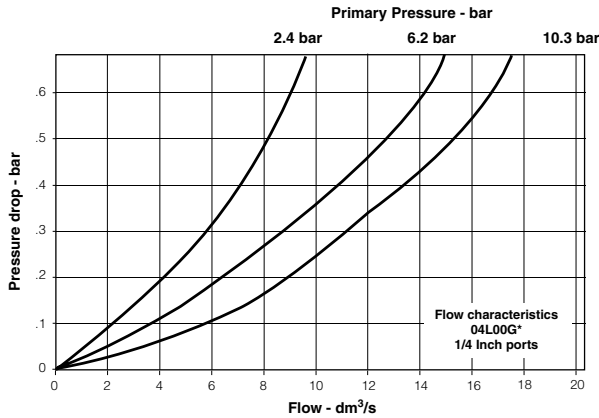
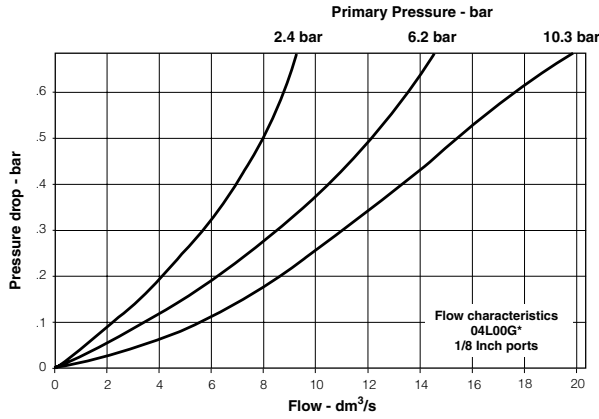

**04L Mist Lubricator Kits & Accessories**

**Bowl Kits –**

Poly Bowl – No Drain ..... PS421P

**Specifications**

- Bowl Capacity ..... 30 cm<sup>3</sup>
- Minimum Flow for Lubrication ..... 0.2 dm<sup>3</sup>/s at 6.9 bar
- Port Threads ..... 1/8, 1/4 Inch
- Pressure & Temperature Ratings –  
 Polycarbonate Bowl – 0 to 10.3 bar  
 0°C to 52°C
- Weight ..... 180 g

**Materials of Construction**

- Body ..... Zinc
- Bowls – Transparent ..... Polycarbonate
- Seals ..... Nitrile
- Sight Dome ..... Polycarbonate

**Mounting Bracket Kits**

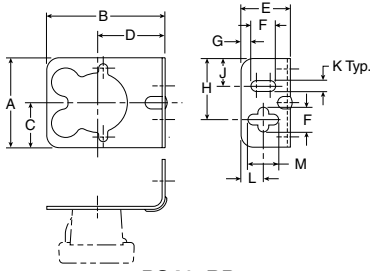

**PS417BP**

(Includes Panel Mount Nut)

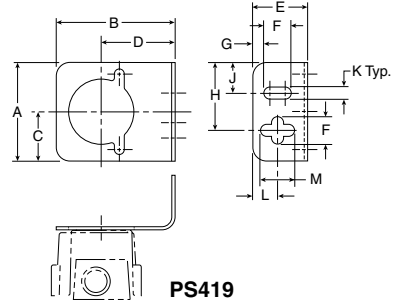

**PS419**

**Dimensions (mm)**

A	B	C	D	E	F	G	H	J	K	L	M	Kit
46	60	23	34	25	13	5	31	14	6	11	16	<b>PS417BP</b> (10F, 14F, 14R, 14E)
46	55	23	34	25	13	5	31	14	6	11	16	<b>PS419</b> (04L)