



# Directional control valves

**Series Flowstar**

**VDMA 24563**

*Catalogue 9127007212GB-ul*

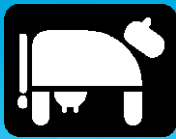



## WARNING

FAILURE OR IMPROPER SELECTION OR IMPROPER USE OF THE PRODUCTS AND/OR SYSTEMS DESCRIBED HEREIN OR RELATED ITEMS CAN CAUSE DEATH, PERSONAL INJURY AND PROPERTY DAMAGE.

This document and other information from Parker Hannifin Corporation, its subsidiaries and authorized distributors provide product and/or system options for further investigation by users having technical expertise. It is important that you analyze all aspects of your application and review the information concerning the product or system in the current product catalog. Due to the variety of operating conditions and applications for these products or systems, the user, through its own analysis and testing, is solely responsible for making the final selection of the products and systems and assuring that all performance, safety and warning requirements of the application are met. The products described herein, including without limitation, product features, specifications, designs, availability and pricing, are subject to change by Parker Hannifin Corporation and its subsidiaries at any time without notice.

## SALE CONDITIONS

The items described in this document are available for sale by Parker Hannifin Corporation, its subsidiaries or its authorized distributors. Any sale contract entered into by Parker will be governed by the provisions stated in Parker's standard terms and conditions of sale (copy available upon request).

## Summary

## Page

General information .....	4-6
Multiple mounting with bottom connection .....	7
Multiple manifold with side connection .....	8
Technical data .....	9
Order key .....	10-11
Main data, pneumatically actuated .....	12-13
Main data, electrically actuated .....	14-17
Accessories, subbase and multiple manifolds .....	18-24
Complete valves .....	24-25
Solenoid valves .....	26-30
Valvetronic 110 .....	31
Pre-wired solenoid connector .....	32
Ready-to-use cable .....	32
Plug assembly instruction .....	35



### Important !

Before carrying out any service work, ensure that the valve and manifold have been vented. Remove the primary supply air hose to ensure total disconnection of the air supply before dismantling valves or blind connection blocks.



= Products specially suitable for the food industry.

### NB!

The air quality is decisive for the valve life: see ISO 8573.

### NB!

All technical data in this catalogue is typical only.

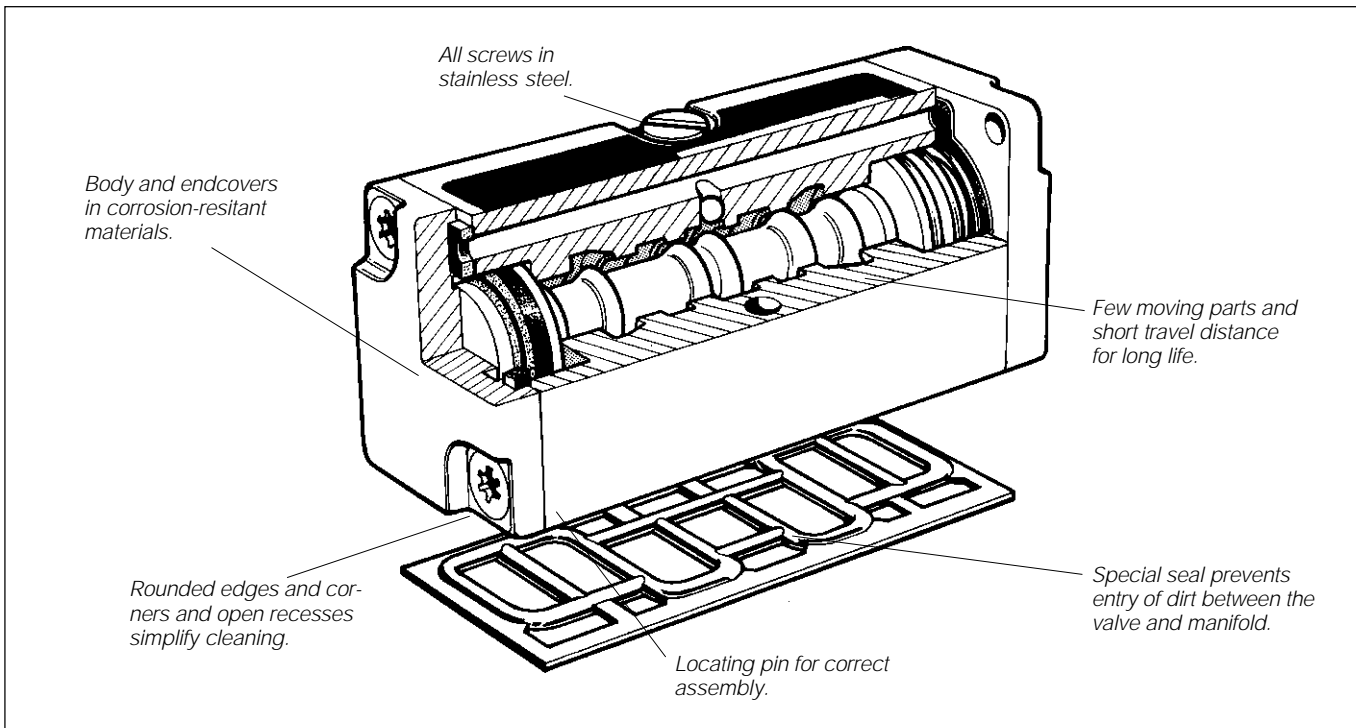

## The P2V-A/B valve range

**P2V-A, G1/8, 18 mm wide and P2V-B, G1/4, 26 mm wide, VDMA 24563**

The P2V-A/B range of valves are 5-port directional control valves, complying with the 18 and 26 mm wide VDMA 24563 specification. The objective behind the development of this standard was to produce a valve concept in which the manifold was considerably narrower than that of ISO 5599/1, Size 1, suiting the needs of modern machines for more compact equipment. The range includes a large number of pneumatically or electrically operated 5/2 and 5/3 valves.

The pilot valve used for electrical control will shortly comply with a CNOMO standard. It has three ports in the connection plane: one for supply air, one for signal air and one for venting.

Manifolds are available for single mounting with side connections, as well as for multiple valves with bottom/ side connections.

### A standard to rely on

The P2V-A/B range provides full interchangeability with the German VDMA 24563 standard (18 mm and 26 mm). The pilot valves of the electrically activated valves comply with a new French CNOMO standard for the hole pattern of the connecting block which is being drafted. Connections for the cable connector comply with Form C of DIN 43650.

### Substantially smaller than ISO1 valves

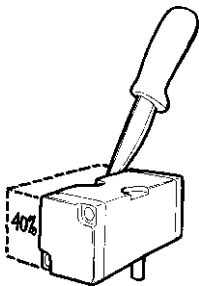

The width of the manifold of P2V-A valves is about 60% less than that of normal ISO1 valves, while that of the P2V-B valves is about 40% less, which means that more valves can be accommodated in the same space.

### Extremely high flow capacity

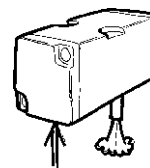

Flow rates through P2V-B valves are about 10% higher than for the majority of ISO 1 valves (P2V-B C = 4.4 NI/s, bar). Flows through the valve itself are so high that it is the standardised hole connection pattern that prevents higher flow rates being achieved.

### Corrosion-resistant design

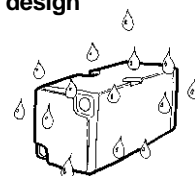

The materials in the valves and manifolds have been selected for extremely high performance in respect of corrosion resistance. Valve bodies and manifolds are anodised aluminium, end covers are thermoplastic and the use of stainless steel for all screws result in excellent durability.

## High reliability

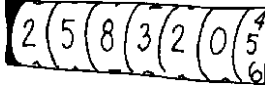

The valves easily meet the requirements for component reliability in the EN 292-2 and EN 983 EU Machinery Directive.

Few moving parts and short travel distance for the valve spool result in high reliability and long life. Valves in the P2V-A/B range have also been designed to work with compressed air without additional lubrication. The valves operate on well-proven principles and have shown themselves to fulfil exceptionally high standards in respect of reliability and long life.

## Clean lines suitable for food industry applications

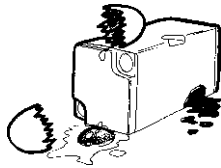

The P2V-A/B range has been designed in conjunction with several machine manufacturers and organisations in the food industry, with corrosion-resistant materials and smooth lines being important starting points. The valves and manifolds have been designed so that there are no gaps or crevices in which dirt could collect. The valves can therefore be installed in the splash area.

## Cleanliness and low noise

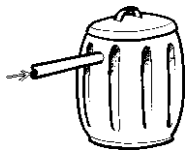

The exhaust air from the pilot valves is led down through the valve and out via the manifold, so that all exhausts can be made common. This is particularly important for applications requiring clean working conditions and low noise level. Collection of the exhaust air for silencing and cleaning fulfils sections 1.5.8 (Noise) and 1.5.14 (Emission of dust, gases etc.) of the EU Machine Directive.

## High electric protection class

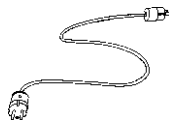

The pilot valves are in protection class IP65, with a standard cable head. Cable heads with higher protection class raise the overall protection class to IP67.

## Several different types of cable head

Cable heads are available with or without spark arrestors, LEDs and rectifiers, for connecting your own cable or using incapsulated cable. A large range of variants ensures all requirements to be met.

## Insensitive to dirty air



The use of high cross-sectional areas in the air channels, together with a 1.0 mm orifice in the pilot valves, means that P2V-A/B valves can be used in normal industrial environments without problems of blocking. However, the cleaner the air, the longer the life.

## Seals between the valve and manifold

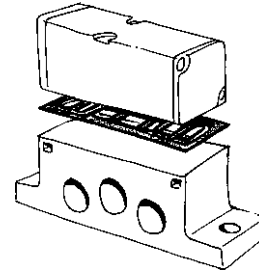

A specially designed seal between the valve and manifold, with a positive seal around the outer edge, prevents dirt from finding its way into the gap between the valve and manifold. The fully 'convex' contour guarantees a perfectly clean joint, with no possibility of dirt or bacteria build-up.

## Seals between multiple manifolds

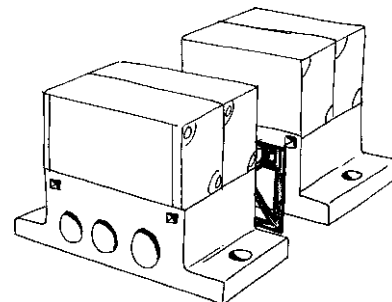

Seals with the same positive sealing principle as described above are also standard between multiple manifolds, ensuring that no dirt can penetrate there either.

## Very low changeover pressure

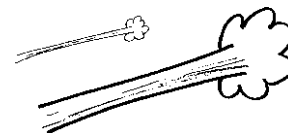

Special models are available with double actuation pistons to reduce changeover pressure as much as possible (to about 2.0 bar for spring-return valves).

## Spares: simply replace the valve

The valves' long life and low price mean that there is no need to hold stocks of special spare parts.

## Separate air feeds to pilot valves

Other models are available with a separate supply of compressed air to the pilot valves where the valves are handling extremely low pressure or vacuum.

## Common separate feed of compressed air to pilot valves

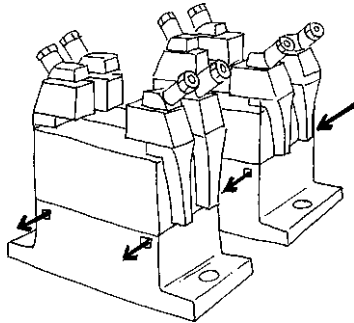

Multiple manifolds have common through channels for separate supply of compressed air to the pilot valves and exhaust from them. Connections can be made to these channels at any connection block. The pilot valves can also be supplied and/or vented individually.

## Rational multiple mounting

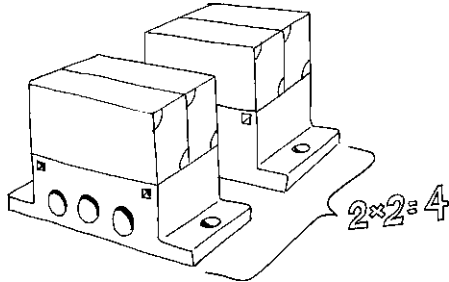

Each multiple manifold is designed with two valve positions to save time and cost when mounting. Only two manifolds are required, for example, to mount four valves, as against four traditional manifolds. This halves the mounting time, while reducing the risk of leakage between manifolds as a result of fewer joints.

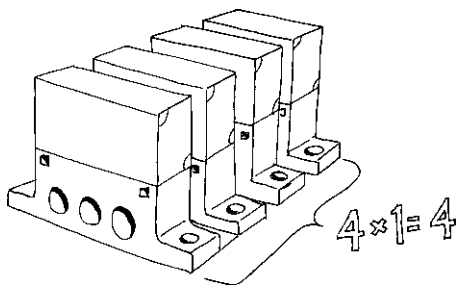

## Flexible connections

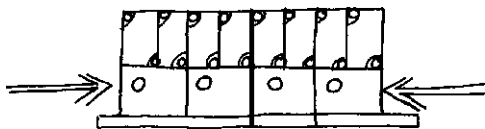

Several variants of connecting blocks are available, allowing connection from the top, bottom or side. Plugs can be fitted to interrupt connections between multiple manifolds, allowing (for example) the two sides of the manifold to be supplied at different pressures.

## Versatile multiple manifolds

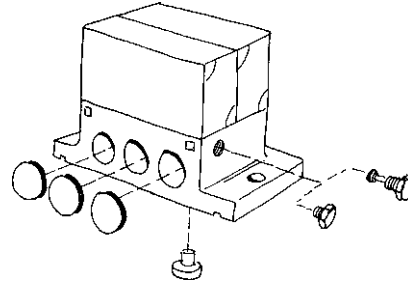

The same multiple manifold can be used for all variants of P2V-A/B valves, whether pneumatically operated or electrically operated and with internal or separate air supply to the pilot valves.

Block connections and applications can be modified to suit specific requirements by fitting or removal of plugs (supplied with the blocks).

## Sealing groove in multiple manifolds

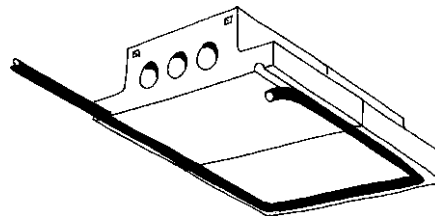

The underside of the multiple manifolds contains a groove for an O-ring-type seal, enabling it to be fitted inside a valve cubicle so that only a single rectangular opening is required for all connections through the cubicle wall, while the seal maintains integrity of the cubicle enclosure in respect of external dust and moisture.

## Compatibility with control systems

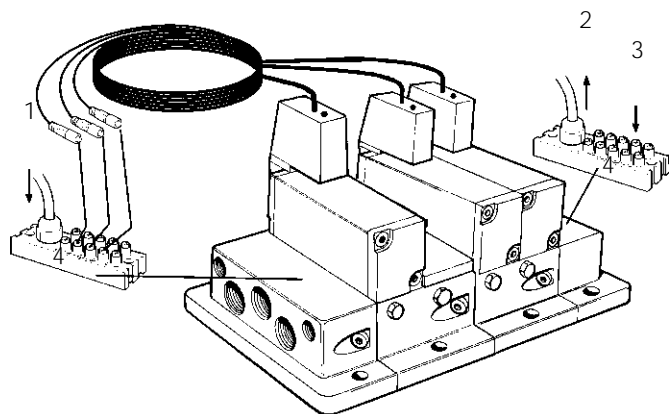

1. Output signals from the control system
2. Input signals to the control system
3. Sensor signals to the Valvetronic unit
4. Valvetronic 110

Used with the Valvetronic, the P2V-A/B valves provide a simple and easily-monitored electrical installation with high physical protection class.

## Multiple mounting with bottom connection

This system is suitable for use in applications with demanding requirements in respect of protection against dirt and ease of cleaning.

Suitable for food industry and similar applications.

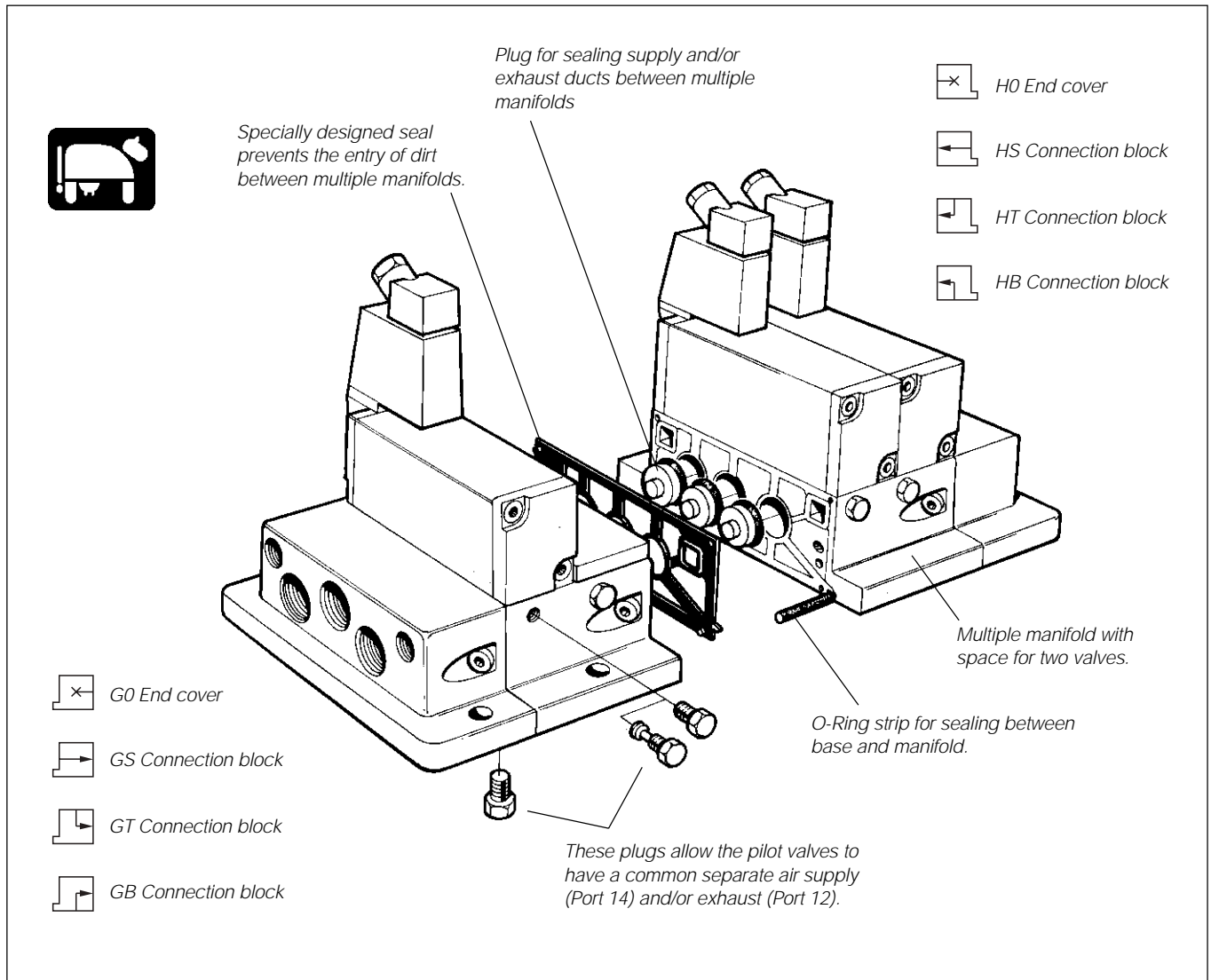

## Multiple manifold with side connections (P2V-A only)

This system is intended for use in applications requiring side connection of the manifold with as low a height as possible. The manifolds allow air to the working unit from ports 2 and 4 to be connected to either or both sides. The manifolds are also suitable for fitting to a DIN mounting bar for speed and simplicity of installation. However, as there are no seals to prevent the entry of dirt between the manifolds, they should be installed in cabinets for food industry applications.

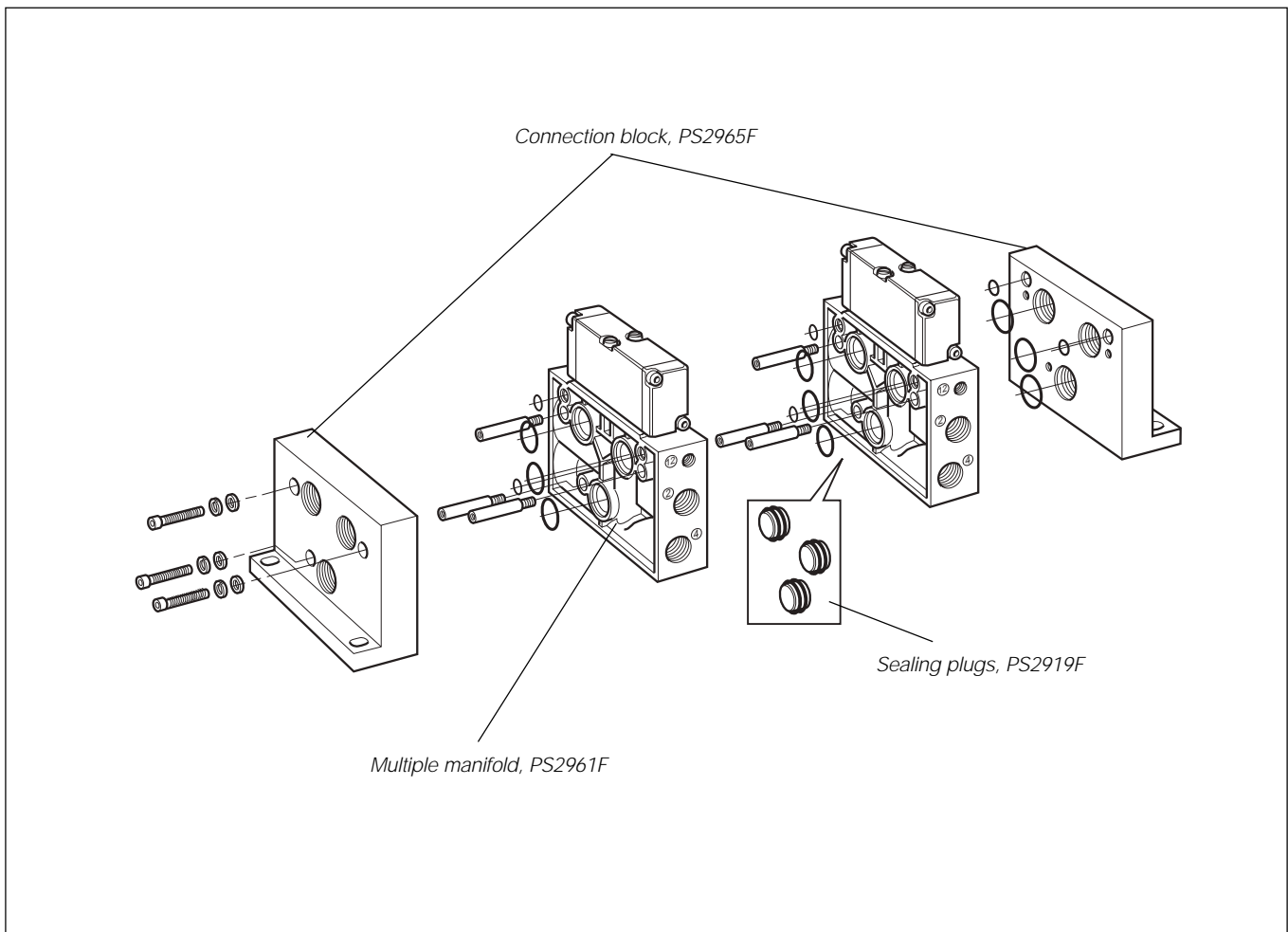



## Flow characteristics P2V-A

Flow capacities in accordance with ISO6358.  
All pressures = effective pressure  
The curves in the diagram below are typical only.

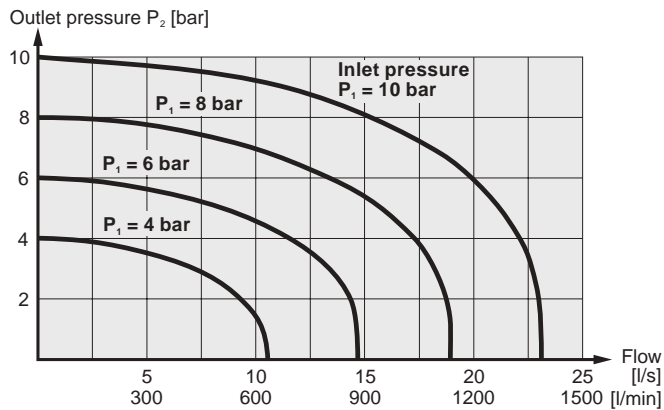

## Flow characteristics P2V-B

Flow capacities in accordance with ISO6358.  
All pressures = effective pressure  
The curves in the diagram below are typical only.

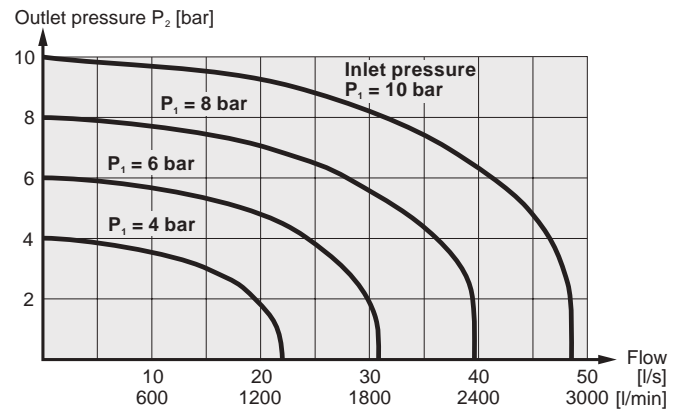

## Technical data

### P2V-A

Dimension	G1/8,VDMA 24563 18 mm wide
Operating pressure, max	10 bar
Operating temperature range	-10 to +70 °C, pneum. actuated -10 to +60 °C, electr. actuated
Flow (Acc. to ISO 6358) (Valve flow measured on the valve including manifold)	C=2,1 NI/s x bar b=0,25 Qn=8,6 l/s Qmax=14,7 l/s Cv=0,51

### P2V-B

Dimension	G1/4,VDMA 24563 26 mm wide
Operating pressure, max	10 bar
Operating temperature range	-20 to +70 °C, pneum. actuated -15 to +60 °C, electr. actuated
Flow (Acc. to ISO 6358) (Valve flow measured on the valve including manifold)	C=4,4 NI/s x bar b=0,25 Qn=18,1 l/s Qmax=30,8 l/s Cv=1,08

## Materials

### Valve

Valve body	Anodised aluminium
End covers	Thermoplastic
End screws	Stainless steel
Spool	Aluminium and nitrile rubber
Piston	Thermoplastic
U-rings, seals	Nitrile rubber
Springs	Dacromet® - processed steel
Mounting screws	Stainless steel

### Single manifold

Manifolds	Anodised aluminium
-----------	--------------------

### Multiple mounting with bottom connection

Manifolds	Anodised aluminium
Connection blocks and end covers	Anodised aluminium
Blind plate	Anodised aluminium
Plugs on multiple manifolds	Red thermoplastic and stainless steel
Mounting screws	Stainless steel

### Multiple mounting with side connection

Multiple manifold, P2V-A-1	Reinforced thermoplastic
Threaded inserts	Brass
Tie rods	Surface-treated steel
O-rings	Nitrile rubber
Connection sets	Anodised aluminium

## Order key, basic valves

<b>P 2 V -</b>	<b>A</b>	<b>V</b>	<b>5</b>	<b>0 0</b>	<b>E E</b>	<b>6</b>	<b>C</b>	<b>S</b>																													
<table border="1" style="width: 100%; border-collapse: collapse;"> <tr><th colspan="2">Valve family</th></tr> <tr><td><b>P2V</b></td><td>VDMA-valves</td></tr> </table>		Valve family		<b>P2V</b>	VDMA-valves			<table border="1" style="width: 100%; border-collapse: collapse;"> <tr><th colspan="2">Actuation/Return</th></tr> <tr><td><b>D</b></td><td> Differential piston (air spring return only.)</td></tr> <tr><td><b>E</b></td><td> Electrically actuated/returned</td></tr> <tr><td><b>J</b></td><td> Electrically actuated/returned double piston area</td></tr> <tr><td><b>P</b></td><td> Pneumatically actuated/returned</td></tr> <tr><td><b>Q</b></td><td> Pneumatically actuated/returned double piston area</td></tr> <tr><td><b>S</b></td><td> Spring returned</td></tr> </table>		Actuation/Return		<b>D</b>	Differential piston (air spring return only.)	<b>E</b>	Electrically actuated/returned	<b>J</b>	Electrically actuated/returned double piston area	<b>P</b>	Pneumatically actuated/returned	<b>Q</b>	Pneumatically actuated/returned double piston area	<b>S</b>	Spring returned	<table border="1" style="width: 100%; border-collapse: collapse;"> <tr><th colspan="2">Type of current</th></tr> <tr><td></td><td>Without solenoid</td></tr> <tr><td><b>1</b></td><td>AC 50 Hz</td></tr> <tr><td><b>2</b></td><td>DC</td></tr> <tr><td><b>3</b></td><td>AC 60 Hz</td></tr> <tr><td><b>6</b></td><td>AC/DC</td></tr> </table>		Type of current			Without solenoid	<b>1</b>	AC 50 Hz	<b>2</b>	DC	<b>3</b>	AC 60 Hz	<b>6</b>	AC/DC
Valve family																																					
<b>P2V</b>	VDMA-valves																																				
Actuation/Return																																					
<b>D</b>	Differential piston (air spring return only.)																																				
<b>E</b>	Electrically actuated/returned																																				
<b>J</b>	Electrically actuated/returned double piston area																																				
<b>P</b>	Pneumatically actuated/returned																																				
<b>Q</b>	Pneumatically actuated/returned double piston area																																				
<b>S</b>	Spring returned																																				
Type of current																																					
	Without solenoid																																				
<b>1</b>	AC 50 Hz																																				
<b>2</b>	DC																																				
<b>3</b>	AC 60 Hz																																				
<b>6</b>	AC/DC																																				
<table border="1" style="width: 100%; border-collapse: collapse;"> <tr><th colspan="2">Size</th></tr> <tr><td><b>A</b></td><td>18 mm wide</td></tr> <tr><td><b>B</b></td><td>26 mm wide</td></tr> </table>		Size		<b>A</b>	18 mm wide	<b>B</b>	26 mm wide					<table border="1" style="width: 100%; border-collapse: collapse;"> <tr><th colspan="2">Voltage</th></tr> <tr><td></td><td>Without solenoid</td></tr> <tr><td><b>C</b></td><td>24 V</td></tr> <tr><td><b>F</b></td><td>115 V</td></tr> <tr><td><b>J</b></td><td>230 V</td></tr> </table>		Voltage			Without solenoid	<b>C</b>	24 V	<b>F</b>	115 V	<b>J</b>	230 V														
Size																																					
<b>A</b>	18 mm wide																																				
<b>B</b>	26 mm wide																																				
Voltage																																					
	Without solenoid																																				
<b>C</b>	24 V																																				
<b>F</b>	115 V																																				
<b>J</b>	230 V																																				
<table border="1" style="width: 100%; border-collapse: collapse;"> <tr><th colspan="2">Valve type/Function</th></tr> <tr><td colspan="2">Pneumatically and electrically actuated with internal supply to solenoid valve(s)</td></tr> <tr><td><b>5</b></td><td> 5/2 valve</td></tr> <tr><td><b>6</b></td><td> 5/3 valve Closed centre position</td></tr> <tr><td><b>7</b></td><td> 5/3 valve Pressurised centre position</td></tr> <tr><td><b>8</b></td><td> 5/3 valve Vented centre position</td></tr> <tr><td colspan="2">Electrically actuated with external supply to solenoid valve(s)</td></tr> <tr><td><b>N</b></td><td> 5/2 valve</td></tr> <tr><td><b>P</b></td><td> 5/3 valve Closed centre position</td></tr> <tr><td><b>Q</b></td><td> 5/3 valve Pressurised centre position</td></tr> <tr><td><b>R</b></td><td> 5/3 valve Vented centre position</td></tr> </table>		Valve type/Function		Pneumatically and electrically actuated with internal supply to solenoid valve(s)		<b>5</b>	5/2 valve	<b>6</b>	5/3 valve Closed centre position	<b>7</b>	5/3 valve Pressurised centre position	<b>8</b>	5/3 valve Vented centre position	Electrically actuated with external supply to solenoid valve(s)		<b>N</b>	5/2 valve	<b>P</b>	5/3 valve Closed centre position	<b>Q</b>	5/3 valve Pressurised centre position	<b>R</b>	5/3 valve Vented centre position					<table border="1" style="width: 100%; border-collapse: collapse;"> <tr><th colspan="2">Overrides/ Cable head</th></tr> <tr><td></td><td>Without solenoid</td></tr> <tr><td><b>S</b></td><td>Spring returned with LED + VDR</td></tr> </table>		Overrides/ Cable head			Without solenoid	<b>S</b>	Spring returned with LED + VDR		
Valve type/Function																																					
Pneumatically and electrically actuated with internal supply to solenoid valve(s)																																					
<b>5</b>	5/2 valve																																				
<b>6</b>	5/3 valve Closed centre position																																				
<b>7</b>	5/3 valve Pressurised centre position																																				
<b>8</b>	5/3 valve Vented centre position																																				
Electrically actuated with external supply to solenoid valve(s)																																					
<b>N</b>	5/2 valve																																				
<b>P</b>	5/3 valve Closed centre position																																				
<b>Q</b>	5/3 valve Pressurised centre position																																				
<b>R</b>	5/3 valve Vented centre position																																				
Overrides/ Cable head																																					
	Without solenoid																																				
<b>S</b>	Spring returned with LED + VDR																																				

### Possible combinations

See pages 12, 14 and 16

## Order key, manifolds and accessories

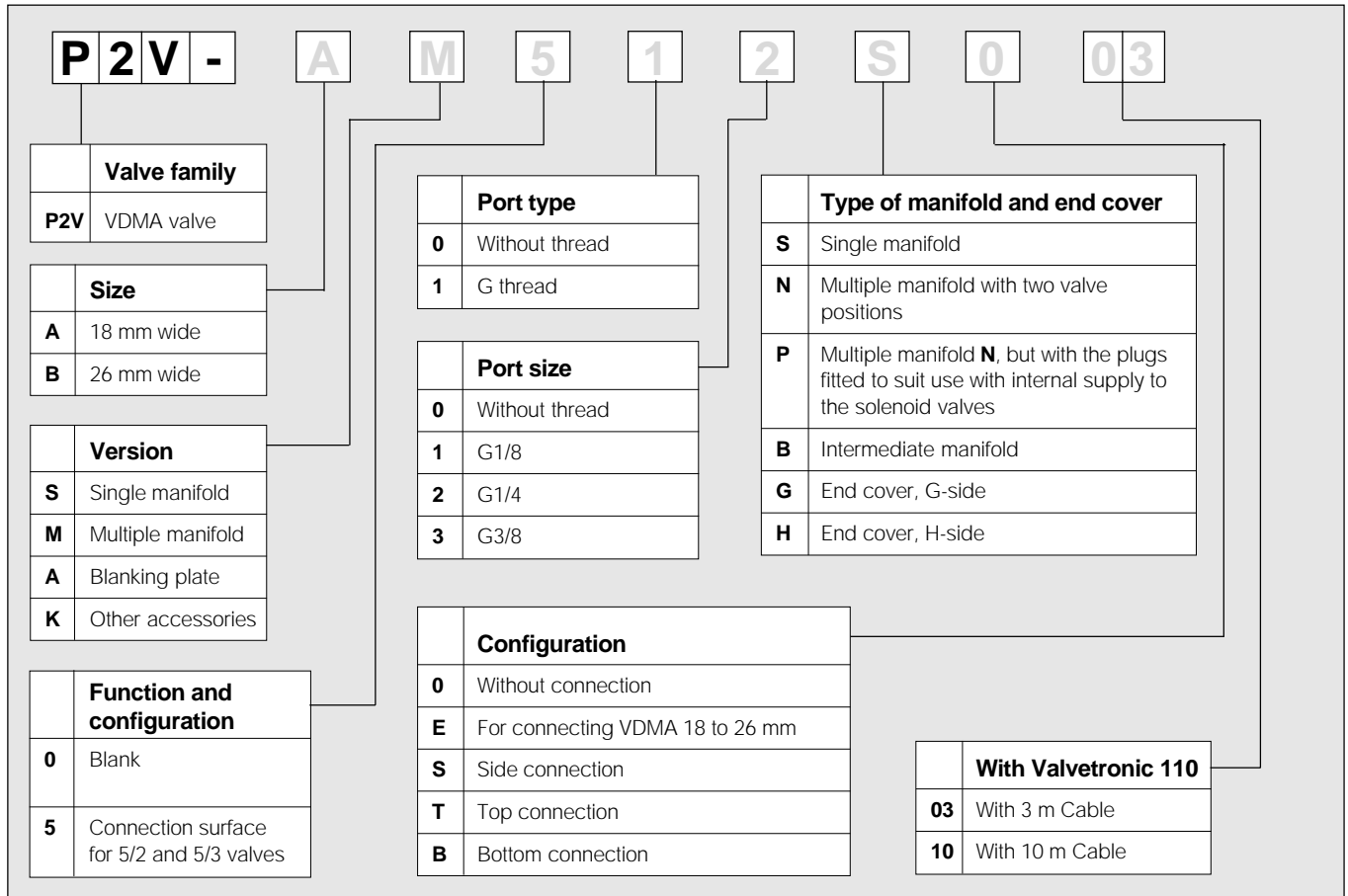





















### Possible combinations

See pages 18 and 19

Accessories on page 23 do not follow this order key!

## Main data directional control valves

Symbol	VDMA size (mm)	Actuation	Return	Signal pressure min. (bar) at 6 bar actua./return	Changeover time (ms) at 6 bar actua./return	Weight (kg)	Order code
<b>Pneumatically actuated 5/2 and 5/3 valves</b>							
 	18 26	Air signal	Air signal	1,5/1,5	10/10	0,07 0,15	<b>P2V-AV500PP</b> <b>P2V-BV500PP</b>
 	18 26	Air signal Double piston	Air signal	1,2/1,5	10/14	0,08 0,18	<b>P2V-AV500QP</b> <b>P2V-BV500QP</b>
 	18 26	Air signal	Spring	3,5/-	13/28	0,07 0,15	<b>P2V-AV500PS</b> <b>P2V-BV500PS</b>
 	18 26	Air signal Double piston	Spring	2,0/-	13/39	0,08 0,18	<b>P2V-AV500QS</b> <b>P2V-BV500QS</b>
 	18 26	Air signal Closed centre position	Air signal Self centring	3,5/3,5	19/40	0,10 0,15	<b>P2V-AV600PP</b> <b>P2V-BV600PP</b>
 	26	Air signal Double piston Closed centre position	Air signal Double piston Self centring	2,0/2,0	19/55	0,21	<b>P2V-BV600QQ</b>
 	18 26	Air signal Vented centre position	Air signal Self centring	3,5/3,5	19/40	0,10 0,15	<b>P2V-AV800PP</b> <b>P2V-BV800PP</b>
 	26	Air signal Double piston Vented centre position	Air signal Double piston Self centring	2,0/2,0	19/55	0,21	<b>P2V-BV800QQ</b>
 	18 26	Air signal Pressurised centre position	Air signal Self centring	3,5/3,5	19/40	0,10 0,15	<b>P2V-AV700PP</b> <b>P2V-BV700PP</b>
 	26	Air signal Double piston Pressurised centre position	Air signal Double piston Self centring	2,0/2,0	19/55	0,21	<b>P2V-BV700QQ</b>

Q in the valve type number (e.g. P2V-AV500QS) indicates a double piston with lower changeover pressure.

**Manifolds and multiple mounting**  
See pages 18 to 24.

## Dimensions

Pneumatically actuated 5/2 and 5/3 valves

\*P2V-AV500PP  
\*P2V-AV500PS

\*\*P2V-BV500PP  
\*\*P2V-BV500PS  
\*\*P2V-BV600PP  
\*\*P2V-BV800PP  
\*\*P2V-BV700PP

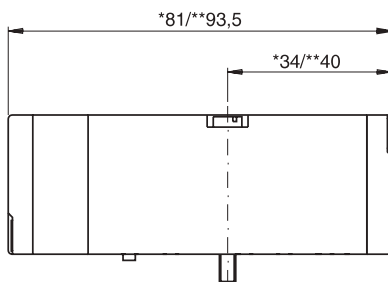
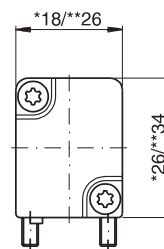
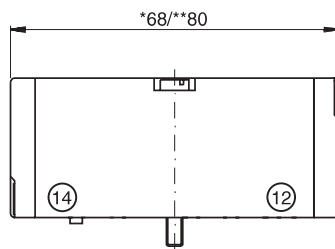

\*P2V-AV500QP  
\*P2V-AV500QS



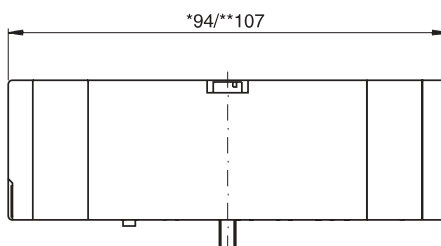













\*\*P2V-BV500QP  
\*\*P2V-BV500QS



\*P2V-AV600PP  
\*P2V-AV800PP  
\*P2V-AV700PP

\*\*P2V-BV600QQ  
\*\*P2V-BV800QQ  
\*\*P2V-BV700QQ

## Main data directional control valves

Symbol	VDMA size (mm)	Actuation	Return	Signal pressure min. (bar) at 6 bar actua./return	Changeover time (ms) at 6 bar actua./return	Weight (kg)	Order code	
<b>Electrically actuated 5/2 valves</b>								
Internal supply to solenoid valve(s) via port 1								
		18 26	Electric signal	Electric signal	1,5/1,5	20/20	0,08 0,16	<b>P2V-AV500EE</b> <b>P2V-BV500EE</b>
		18 26	Electric signal	Spring	3,5/-	20/30	0,08 0,15	<b>P2V-AV500ES</b> <b>P2V-BV500ES</b>
		18 26	Electric signal	Air spring	3,5/-	15/30	0,08 0,15	<b>P2V-AV500JD</b> <b>P2V-BV500JD</b>
		18 26	Electric signal	Spring	2,0/-	22/42	0,09 0,18	<b>P2V-AV500JS</b> <b>P2V-BV500JS</b>
<b>Electrically actuated 5/2 valves</b>								
External supply to solenoid valve(s) via port 14 *								
		18 26	Electric signal	Electric signal	1,5/1,5	20/20	0,08 0,16	<b>P2V-AVN00EE</b> <b>P2V-BVN00EE</b>
		18 26	Electric signal	Spring	3,5/-	20/30	0,08 0,16	<b>P2V-AVN00ES</b> <b>P2V-BVN00ES</b>
		18 26	Electric signal	Air spring	3,5/-	15/30	0,08 0,16	<b>P2V-AVN00JD</b> <b>P2V-BVN00JD</b>
		18 26	Electric signal	Spring	2,0/-	19/55	0,09 0,19	<b>P2V-AVN00JS</b> <b>P2V-BVN00JS</b>

\*Or through a common air channel in the manifold (14) for separate supply.  
The solenoid valves are vented through a common channel (12) in the manifold.  
J in the valve order code 500JS and N00JS indicates a double piston with lower changeover pressure.

**Solenoid valves**

Solenoid valves and cable heads must be ordered separately.  
Use P2E-•V as pilot valves in the above valves. A pilot valve is required for each E or J in the valve order code.

**Complete valves**

See pages 24 and 25

**Manifolds and multiple mounting**

See pages 18 to 24

**Solenoid valves**

See page 26

## Dimensions

Electrically actuated 5/2 valve

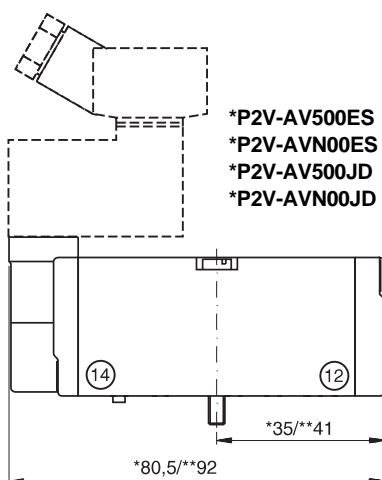

\*P2V-AV500ES  
\*P2V-AVN00ES  
\*P2V-AV500JD  
\*P2V-AVN00JD

\*\*P2V-BV500ES  
\*\*P2V-BVN00ES  
\*\*P2V-BV500JD  
\*\*P2V-BVN00JD

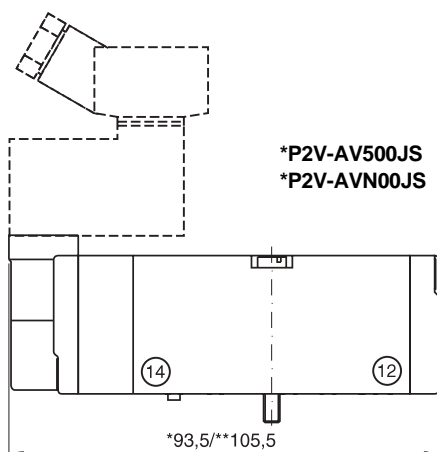
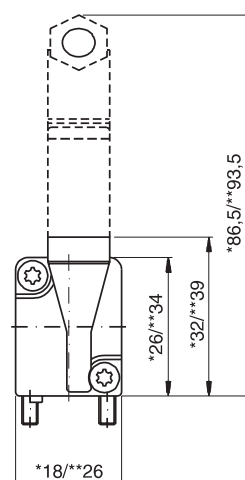

\*P2V-AV500JS  
\*P2V-AVN00JS



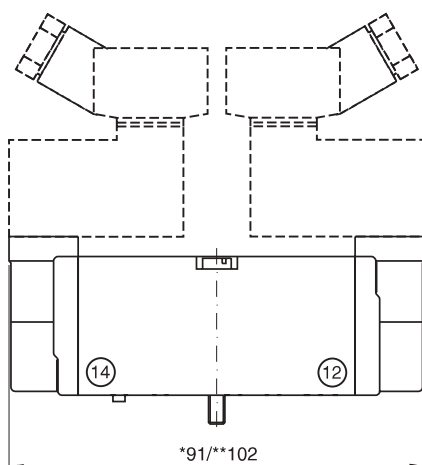



\*\*P2V-BV500JS  
\*\*P2V-BVN00JS

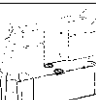
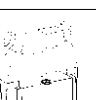

\*P2V-AV500EE  
\*P2V-AVN00EE

\*\*P2V-BV500EE  
\*\*P2V-BVN00EE

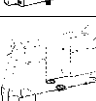
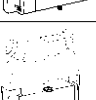
## Main data directional control valves

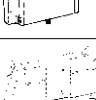
Symbol	VDMA size (mm)	Actuation	Return	Signal pressure min. (bar) at 6 bar actua./return	Changeover time (ms) at 6 bar actua./return	Weight (kg)	Order code
<b>Electrically actuated 5/3 valves</b>							
Internal supply to solenoid valve(s) via port 1							
	18 26	Electric signal Closed centre position	Electric signal Spring Self centring	3,5/-	37/40	0,10 0,16	<b>P2V-AV600EE</b> <b>P2V-BV600EE</b>
	26	Electric signal Double piston Closed centre position	Electric signal Double piston Self centring	2,0/-	37/55	0,21	<b>P2V-BV600JJ</b>
	18 26	Electric signal Vented centre position	Electric signal Self centring	3,5/-	37/40	0,10 0,16	<b>P2V-AV800EE</b> <b>P2V-BV800EE</b>
	26	Electric signal Double piston Vented centre position	Electric signal Double piston Self centring	2,0/-	37/55	0,21	<b>P2V-BV800JJ</b>
	18 26	Electric signal Pressurised centre position	Electric signal Self centring	3,5/-	37/40	0,10 0,16	<b>P2V-AV700EE</b> <b>P2V-BV700EE</b>
	26	Electric signal Double piston Pressurised centre position	Electric signal Double piston Self centring	2,0/-	37/55	0,21	<b>P2V-BV700JJ</b>
<b>Electrically actuated 5/3 valves</b>							
External supply to solenoid valve(s) via port 14 *							
	18 26	Electric signal Closed centre position	Electric signal Self centring	3,5/-	37/40	0,10 0,16	<b>P2V-AVP00EE</b> <b>P2V-BVP00EE</b>
	26	Electric signal Double piston Closed centre position	Electric signal Double piston Self centring	2,0/-	37/55	0,21	<b>P2V-BVP00JJ</b>
	18 26	Electric signal Vented centre position	Electric signal Self centring	3,5/-	37/40	0,10 0,16	<b>P2V-AVR00EE</b> <b>P2V-BVR00EE</b>
	26	Electric signal Double piston Vented centre position	Electric signal Double piston Self centring	2,0/-	37/55	0,21	<b>P2V-BVR00JJ</b>
	18 26	Electric signal Pressurised centre position	Electric signal Self centring	3,5/-	37/40	0,10 0,16	<b>P2V-AVQ00EE</b> <b>P2V-BVQ00EE</b>
	26	Electric signal Double piston Pressurised centre position	Electric signal Double piston Self centring	2,0/-	37/55	0,21	<b>P2V-BVQ00JJ</b>

\*Or through a common air channel in the manifold (14) for separate supply. The solenoid valves are vented through a common channel (12) in the manifold. J in the valve order code **P2V-BV600JJ** for example indicates a double piston with lower changeover pressure.

**Solenoid valves**

Solenoid valves and cable heads must be ordered separately. Use P2E-•V as pilot valves in the above valves. A pilot valve is required for each E or J in the valve order code.



## Dimensions

### Electrically actuated 5/3 valve

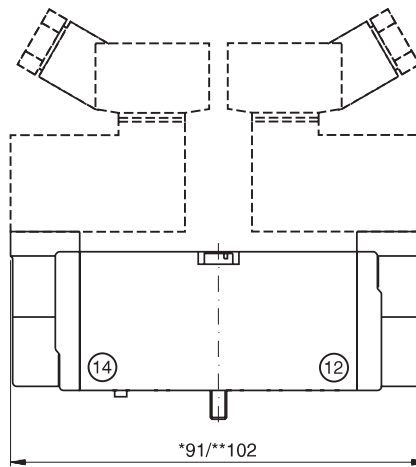
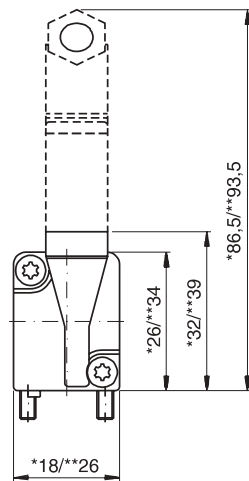

**\*\*P2V-BV600EE**  
**\*\*P2V-BVP00EE**  
**\*\*P2V-BV800EE**  
**\*\*P2V-BVR00EE**  
**\*\*P2V-BV700EE**  
**\*\*P2V-BVQ00EE**

**\*P2V-AV600EE**  
**\*P2V-AVP00EE**  
**\*P2V-AV800EE**  
**\*P2V-AVR00EE**  
**\*P2V-AV700EE**  
**\*P2V-AVQ00EE**

**\*\*P2V-BV600JJ**  
**\*\*P2V-BVP00JJ**  
**\*\*P2V-BV800JJ**  
**\*\*P2V-BVR00JJ**  
**\*\*P2V-BV700JJ**  
**\*\*P2V-BVQ00JJ**

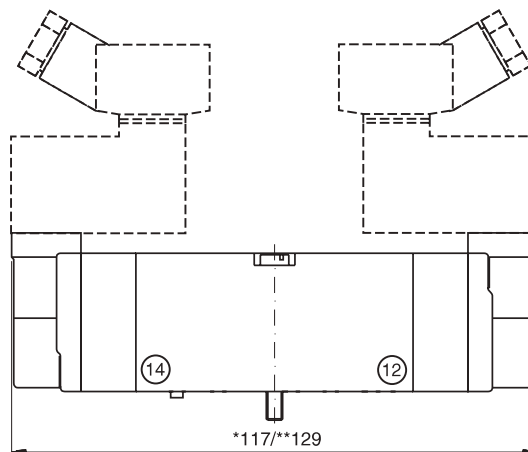

#### Complete valves







See pages 24 and 25



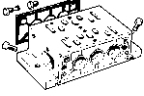

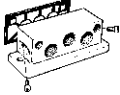

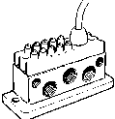
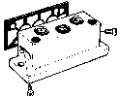
#### Manifolds and multiple mounting

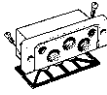
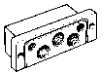
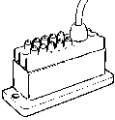
See pages 18 to 24

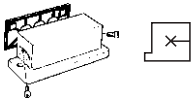
#### Solenoid valves

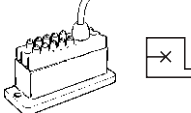
See page 26

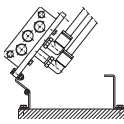
Accessories	Designation	Weight (kg)	Order code (P2V-A, 18 mm)	Weight (kg)	Order code (P2V-B, 26 mm)
	<b>Manifold</b> with side connections	0,07	<b>P2V-AS511SS</b>	0,12	<b>P2V-BS512SS</b>
	<b>Multiple manifold</b> Including seal, fitting screws and plugs. Ports 2, 4, and 14 are bottom-connected. Fit plugs as required to provide common supply of operating air and common exhausts for solenoid valves. Plug assembly instruction, see page 35.	0,20	<b>P2V-AM511NB</b>	0,40	<b>P2V-BM512NB</b>
	<b>Multiple manifold</b> Multiple manifold as above, but with the plugs fitted to suit use with valves with internal supply to solenoid.	0,20	<b>P2V-AM511PB</b>	0,40	<b>P2V-BM512PB</b>
	<b>Intermediate manifold, 18 to 26 mm</b> Including seals and fitting screws. For connecting P2V-AM511NB/PB multiple manifolds to P2V-BM511NB/PB multiple manifolds.	0,33	<b>P2V-AM500BE</b>	0,33	<b>P2V-AM500BE</b>
	<b>Connection block</b> G-side, including seal and fitting screws. For side connection.	0,18	<b>P2V-AM512GS</b>	0,21	<b>P2V-BM513GS</b>
	<b>Connection block</b> H-side. For side connection.	0,18	<b>P2V-AM512HS</b>	0,21	<b>P2V-BM513HS</b>
	<b>Connection block with Valvetronic 110</b> H-side. For side connection. with 3 m cable with 10 m cable	0,50 1,33	<b>P2V-AM512HS03</b> <b>P2V-AM512HS10</b>	0,53 1,36	<b>P2V-BM513HS03</b> <b>P2V-BM513HS10</b>
	<b>Connection block</b> G-side, including seal and fitting screws. For top connection.	0,18	<b>P2V-AM512GT</b>	0,21	<b>P2V-BM513GT</b>
	<b>Connection block</b> H-side. For top connection.	0,18	<b>P2V-AM512HT</b>	0,21	<b>P2V-BM513HT</b>
	<b>Connection block</b> G-side, including seal and fitting screws. For bottom connection.	0,18	<b>P2V-AM512GB</b>	0,22	<b>P2V-BM513GB</b>
	<b>Connection block</b> H-side. For bottom connection.	0,18	<b>P2V-AM512HB</b>	0,22	<b>P2V-BM513HB</b>
	<b>Connection block with Valvetronic 110</b> H-side. For bottom connection. with 3 m cable with 10 m cable	0,50 1,33	<b>P2V-AM512HB03</b> <b>P2V-AM512HB10</b>	0,53 1,36	<b>P2V-BM513HB03</b> <b>P2V-BM513HB10</b>

Accessories	Designation	Weight (kg)	Order code (P2V-A, 18 mm)	Weight (kg)	Order code (P2V-B, 26 mm)
	<b>End cover</b> G-side, including seal and fitting screws.	0,19	<b>P2V-AM500G0</b>	0,24	<b>P2V-BM500G0</b>
	<b>End cover</b> H-side	0,19	<b>P2V-AM500H0</b>	0,24	<b>P2V-BM500H0</b>
	<b>End cover with Valvetronic 110</b> H-side with 3 m cable with 10 m cable	0,51 1,34	<b>P2V-AM500H003</b> <b>P2V-AM500H010</b>	0,54 1,37	<b>P2V-BM500H003</b> <b>P2V-BM500H010</b>
	<b>Blanking plate</b> Including seal and fitting screws.	0,02	<b>PS2973F</b>	0,05	<b>P2V-BA5B</b>
	<b>Plug</b> For sealing supply and exhaust air ducts between multiple manifolds with different primary supply pressures.	0,004	<b>P2V-AK0P</b>	0,01	<b>P2V-BK0P</b>
	<b>Angle mounting set</b> For raising multiple manifolds so that angle connections can be fitted to the underside. The parts are designed so that the entire manifold can be angled to simplify connection of the pipes. The set consists of four mounts, complete with all necessary screws and nuts.	0,14	<b>P2V-AK0M</b>	0,14	<b>P2V-AK0M</b>
	<b>O-ring strip seal</b> For sealing between bases and multiple manifolds. 3.53 mm diameter, Supplied in 5 m lengths.	0,07	<b>9304331543</b>	0,07	<b>9304331543</b>

## Dimensions

### Manifold

\*P2V-AS511SS

\*\*P2V-BS512SS

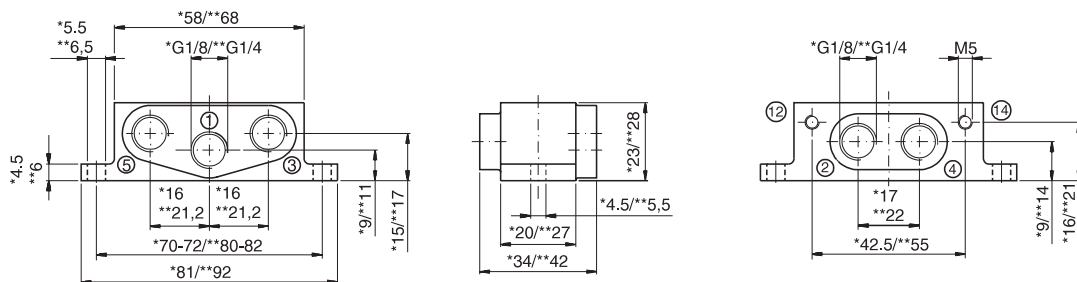

**Dimensions**

**Multiple manifold**

\*P2V-AM511NB, P2V-AM511PB

\*\*P2V-BM512NB, P2V-BM512PB

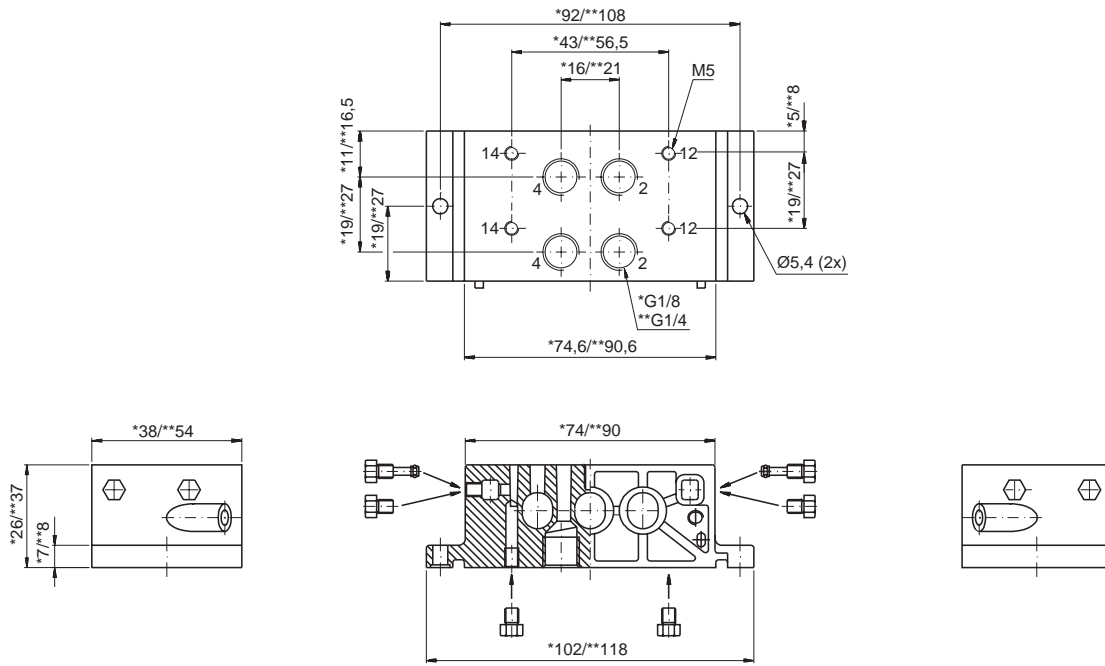

**Intermediate manifold 18 to 26 mm**

**P2V-AM500BE**

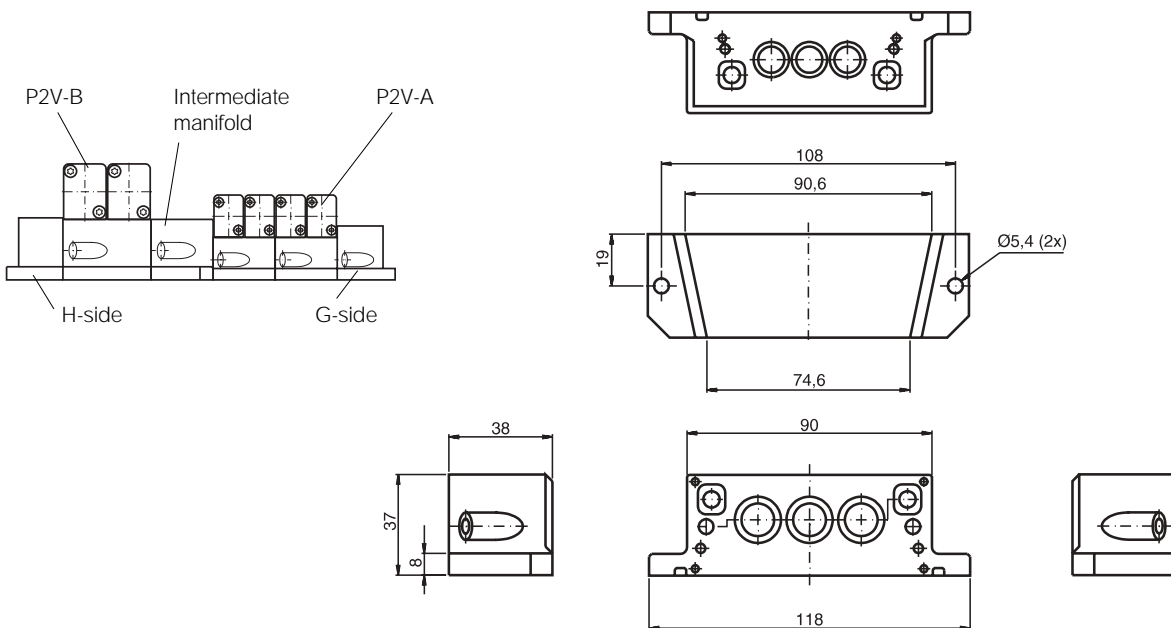

## Connection blocks and end covers

The schematic diagram (right) shows how the connections are positioned on GS, GT, GB, HS, HT and HB connection blocks. Blanking end pieces G0 and H0 (below) have no connection ports. See also overview page 22.

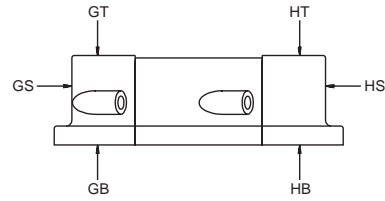

### End cover

- \*P2V-AM512G0/H0
- \*\*P2V-BM512G0/H0

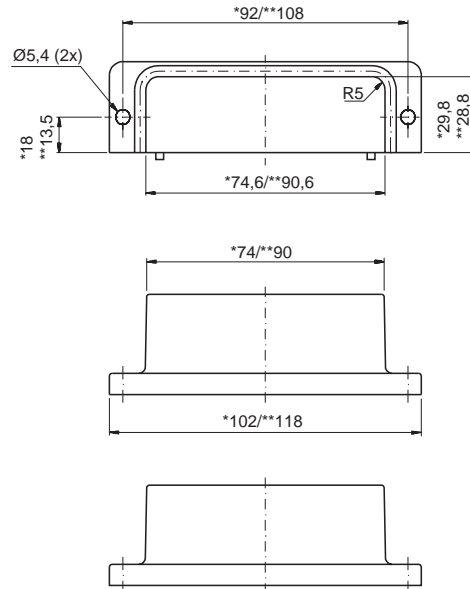
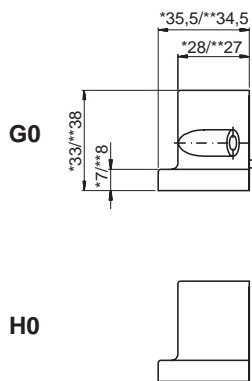

### Connection block

- \*P2V-AM512GS/GT/GB
- \*\*P2V-BM512GS/GT/GB

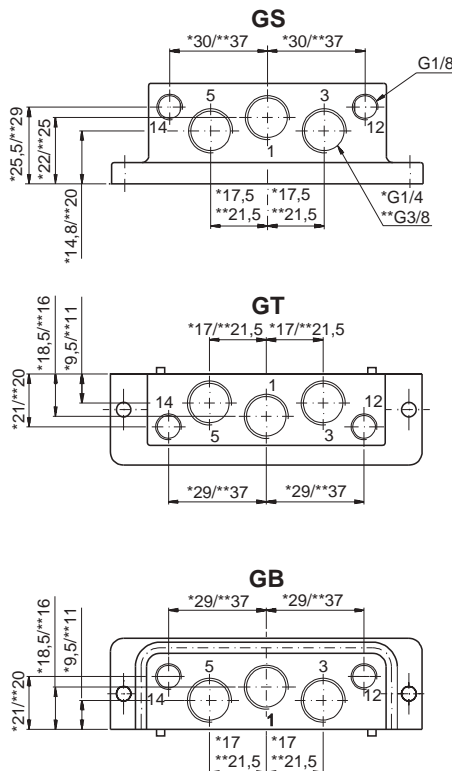

- \*P2V-AM512HS/HT/HB
- \*\*P2V-BM512HS/HT/HB

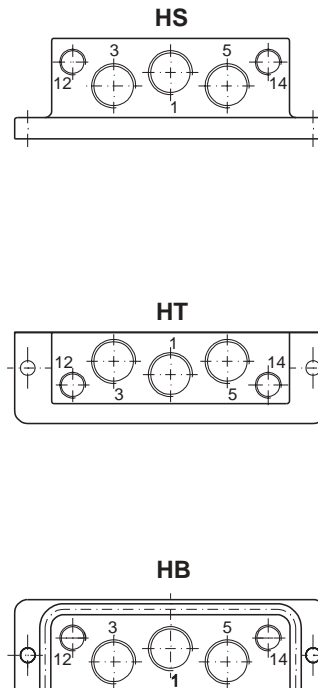

**Dimensions**

**Multiple mounting**

\*P2V-A

\*\*P2V-B

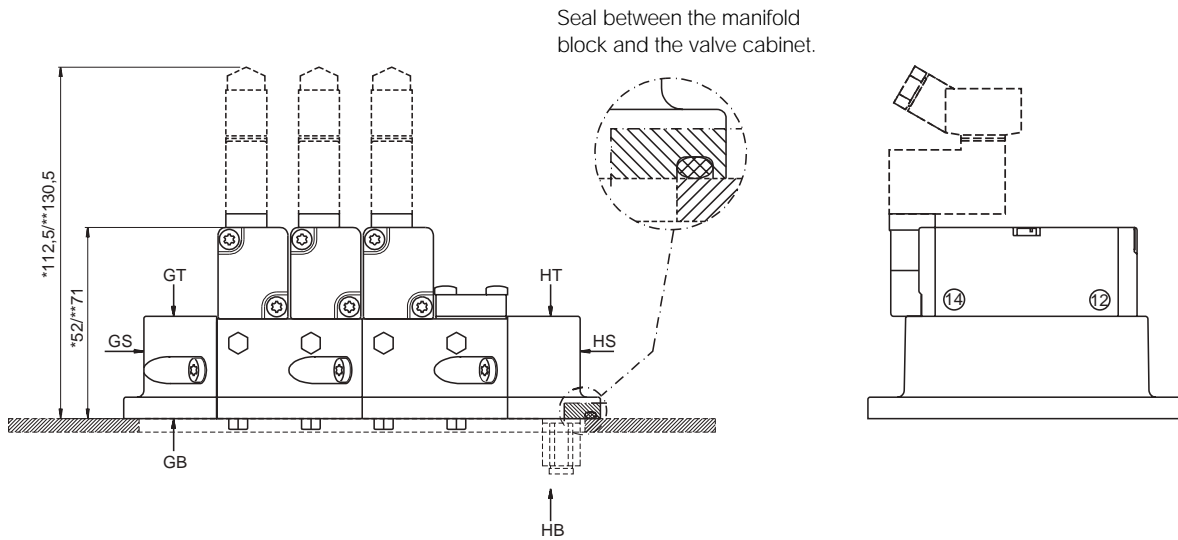
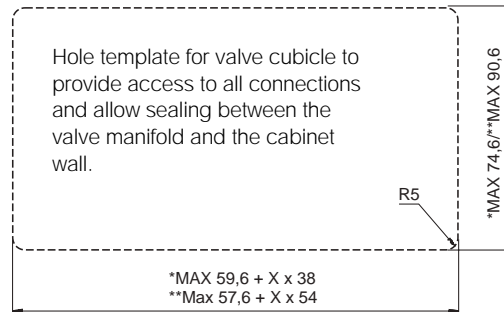
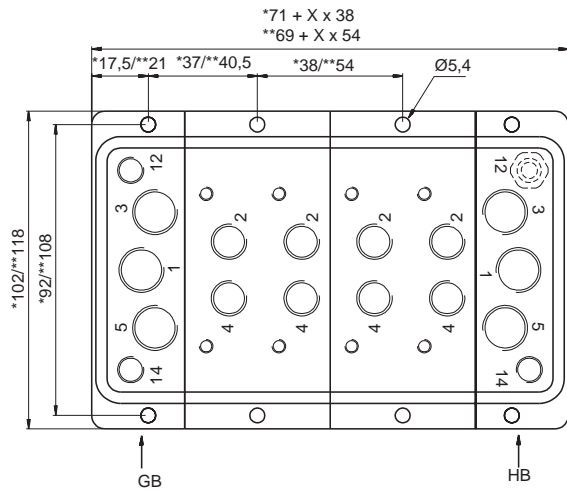

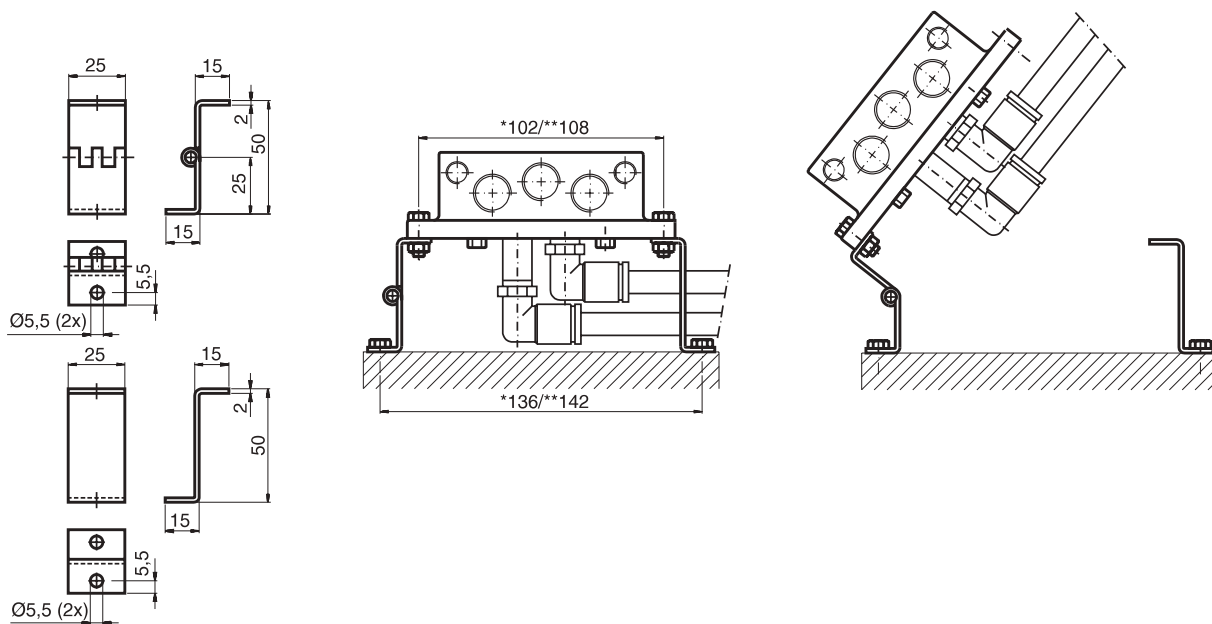

**Angle mounting set**

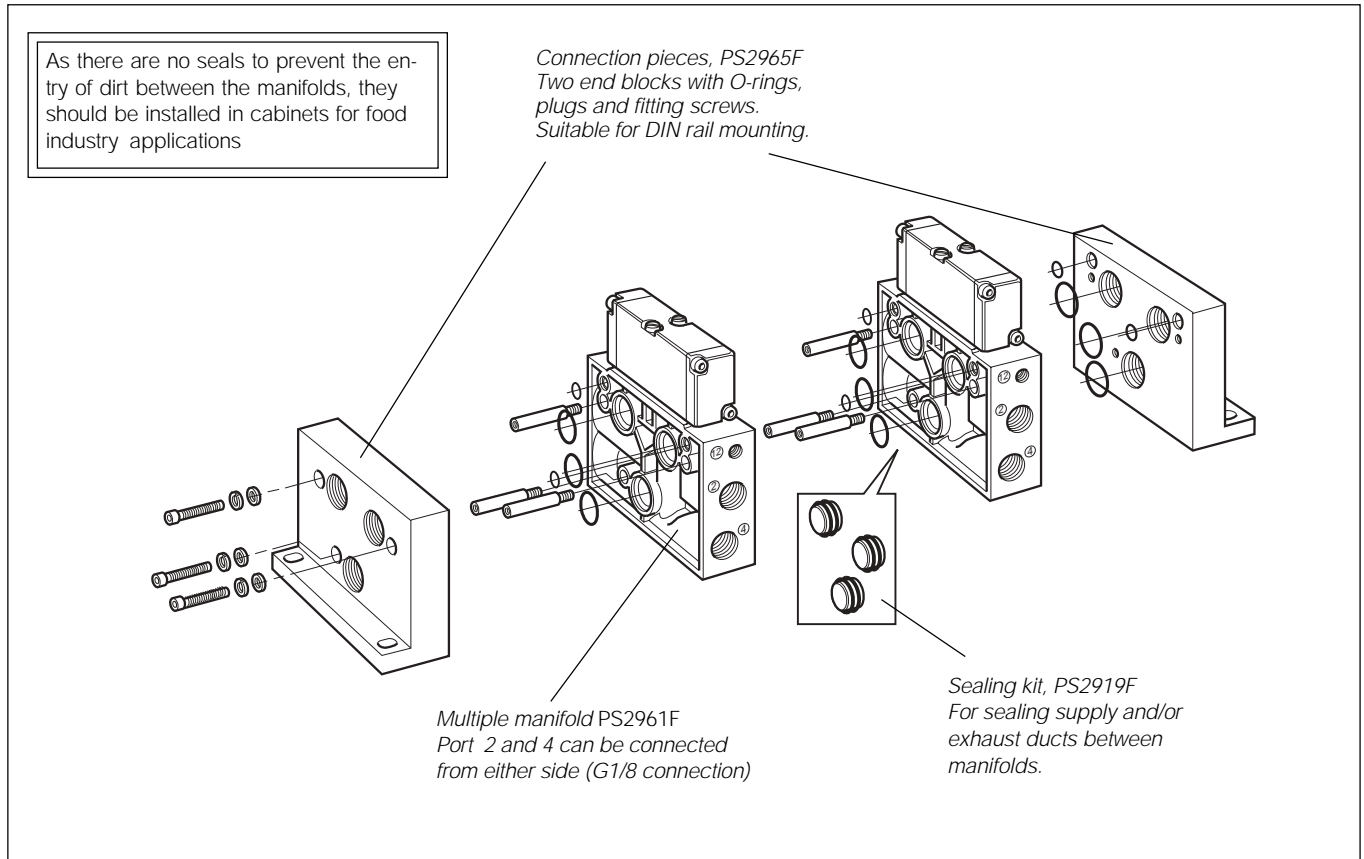

**Multiple manifolds with side connection**

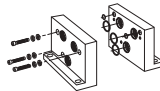
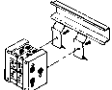

Accessories	Designation (kg)	Weight (kg)	Order code
	<b>Multiple manifold</b> Including O-rings and tie rods. Ports 2, 4, 12 and 14 are brought out to the sides	0,10	<b>PS2961F</b>
	<b>Connection pieces</b> Two end blocks with O-rings, plugs and fitting screws.	0,31	<b>PS2965F</b>
	<b>DIN mounting set</b> For direct mounting.	0,01	<b>PS2970F</b>
	<b>Sealing set</b> Three plugs with O-rings, for sealing supply and exhaust air ducts between multiple manifolds with different primary supply pressures.	0,02	<b>PS2919F</b>
	<b>Blanking plate</b> Including seal and fitting screws.	0,02	<b>PS2973F</b>

**Dimensions**

**Multiple manifolds with side connection**

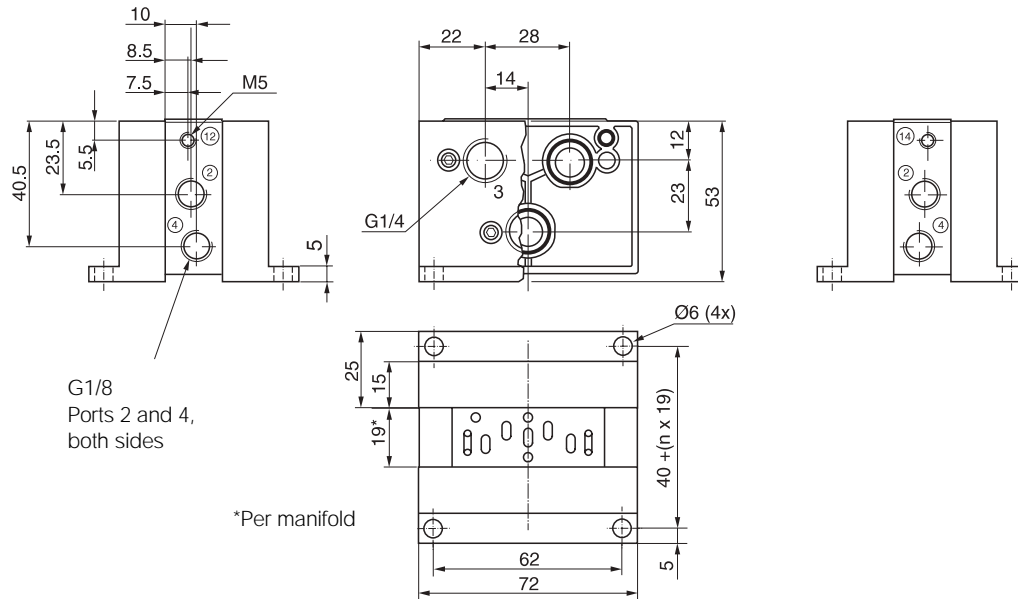

**Complete valves**

with solenoids without base

**P2V-AV500ES**  
18 mm wide

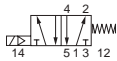

**P2V-BV500ES**  
26 mm wide

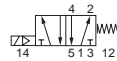

Voltage	Order code
24 V AC/DC	<b>P2V-AV500ES6CS</b> Consisting of: 1 Valve P2V-AV500ES 1 Solenoid P2E-QV32C3 1 Connector P8C-H36C, LED+VDR+REC
110-120 V AC	<b>P2V-AV500ES1FS</b> Consisting of: 1 Valve P2V-AV500ES 1 Solenoid P2E-QV31F3 1 Connector P8C-H21E, LED+VDR
220-240 V AC	<b>P2V-AV500ES1JS</b> Consisting of: 1 Valve P2V-AV500ES 1 Solenoid P2E-QV32C3 1 Connector P8C-H21G, LED+VDR

Voltage	Order code
24 V AC/DC	<b>P2V-BV500ES6CS</b> Consisting of: 1 Valve P2V-BV500ES 1 Solenoid P2E-QV32C3 1 Connector P8C-H36C, LED+VDR+REC
110-120 V AC	<b>P2V-BV500ES1FS</b> Consisting of: 1 Valve P2V-BV500ES 1 Solenoid P2E-QV31F3 1 Connector P8C-H21E, LED+VDR
220-240 V AC	<b>P2V-BV500ES1JS</b> Consisting of: 1 Valve P2V-BV500ES 1 Solenoid P2E-QV32C3 1 Connector P8C-H21G, LED+VDR



## Complete valves

with solenoids without base

### P2V-AV500EE

8 mm wide

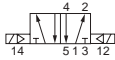

Voltage	Order code
24 V AC/DC	<b>P2V-AV500EE6CS</b> Consisting of: 1 Valve P2V-AV500EE 2 Solenoids P2E-QV32C3 2 Connectors P8C-H36C, LED+VDR+REC
110-120 V AC	<b>P2V-AV500EE1FS</b> Consisting of: 1 Valve P2V-AV500EE 2 Solenoids P2E-QV31F3 2 Connectors P8C-H21E, LED+VDR
220-240 V AC	<b>P2V-AV500EE1JS</b> Consisting of: 1 Valve P2V-AV500EE 2 Solenoids P2E-QV32C3 2 Connectors P8C-H21G, LED+VDR

### P2V-BV500EE

26 mm wide

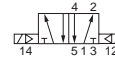

Voltage	Order code
24 V AC/DC	<b>P2V-BV500EE6CS</b> Consisting of: 1 Valve P2V-BV500EE 2 Solenoids P2E-QV32C3 2 Connectors P8C-H36C, LED+VDR+REC
110-120 V AC	<b>P2V-BV500EE1FS</b> Consisting of: 1 Valve P2V-BV500EE 2 Solenoids P2E-QV31F3 2 Connectors P8C-H21E, LED+VDR
220-240 V AC	<b>P2V-BV500EE1JS</b> Consisting of: 1 Valve P2V-BV500EE 2 Solenoids P2E-QV32C3 2 Connectors P8C-H21G, LED+VDR

## Complete valves

with solenoids without base

### P2V-AV600EE/700EE/800EE

8 mm wide

Voltage	Order code
24 V AC/DC	<b>P2V-AV600EE6CS</b> Consisting of: 1 Valve P2V-AV600EE 2 Solenoids P2E-QV32C3 2 Connectors P8C-H36C, LED+VDR+REC
24 V AC/DC	<b>P2V-AV800EE6CS</b> Consisting of: 1 Valve P2V-AV800EE 2 Solenoids P2E-QV32C3 2 Connectors P8C-H36C, LED+VDR+REC
24 V AC/DC	<b>P2V-AV700EE6CS</b> Consisting of: 1 Valve P2V-AV700EE 2 Solenoids P2E-QV32C3 2 Connectors P8C-H36C, LED+VDR+REC

### P2V-BV600EE/700EE/800EE

26 mm wide

Voltage	Order code
24 V AC/DC	<b>P2V-BV600EE66CS</b> Consisting of: 1 Valve P2V-BV600EE 2 Solenoids P2E-QV32C3 2 Connectors P8C-H36C, LED+VDR+REC
24 V AC/DC	<b>P2V-BV800EE6CS</b> Consisting of: 1 Valve P2V-BV800EE 2 Solenoids P2E-QV32C3 2 Connectors P8C-H36C, LED+VDR+REC
24 V AC/DC	<b>P2V-BV700EE6CS</b> Consisting of: 1 Valve P2V-BV700EE 2 Solenoids P2E-QV32C3 2 Connectors P8C-H36C, LED+VDR+REC

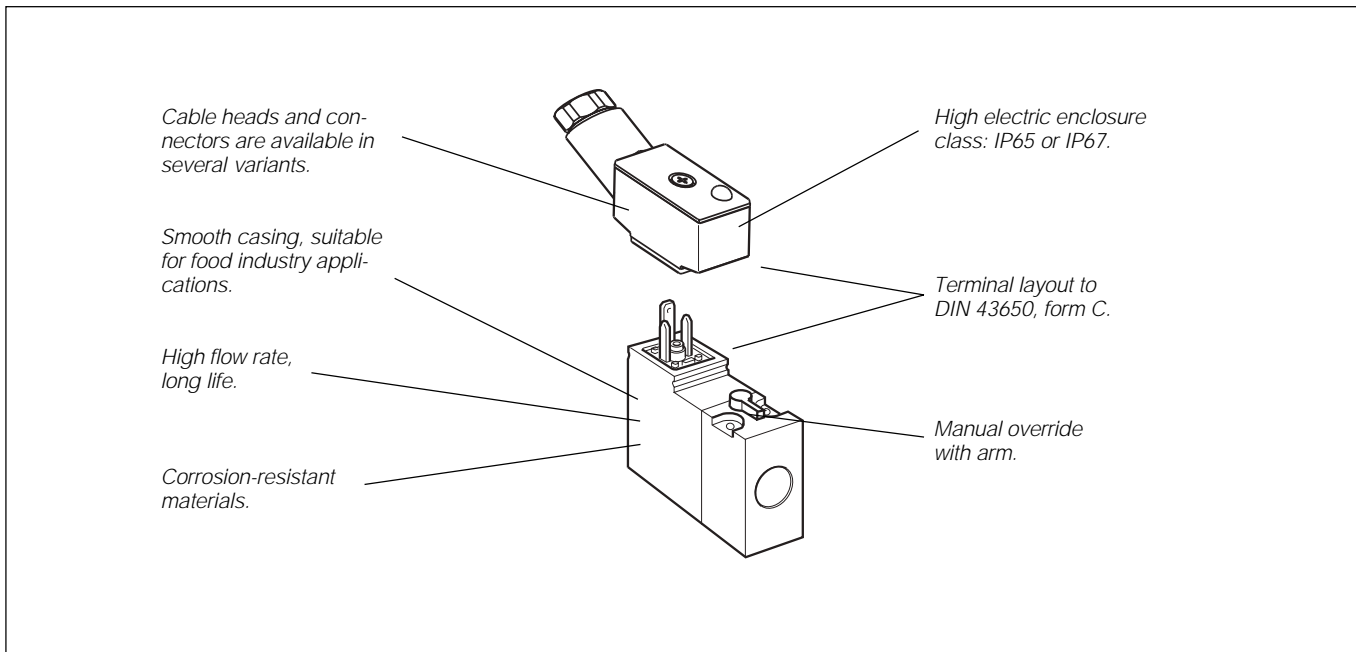

## The P2E-•V solenoid valve range

The P2E-QV range of valves are normally closed (NC) 3/2 solenoid valves, with exceedingly compact dimensions in relation to their capacity.

### International standard

The port connection pattern complies with a new French CNOMO standard (in process of drafting), with cable head connections in accordance with DIN 43650, Form C.

### Compact design

Overall dimensions of the P2E-•V valve are substantially less than those of earlier generations of solenoid valves.

### High flow capacity

High flow capacity relative to the electrical operating power as a result of optimised internal flow paths.

### Corrosion-resistant design

The valve is made of thermoplastic material and stainless steel, with Viton™ and nitrile rubber seals for excellent corrosion resistance.

### Clean lines suitable for food industry applications

The valve has been designed in conjunction with several machine manufacturers and organisations in the food industry, with corrosion-resistant materials and smooth lines being important starting points. The valve and its accessories have been designed so that there are no gaps or crevices in which dirt could collect.

### No external exhaust from the valve

The exhaust air from the pilot valves is led down through the valve and out via the manifold, so that all exhausts can be made common. This is particularly important for applications requiring clean working conditions and low noise level.

### High reliability

Few moving parts result in high reliability, rapid changeover and very long life.

### Low power demand

The valves have a power demand of 1.2 W at 24 V DC and 1.6 VA at 24 V AC, 115 V AC and 230 V AC.

### High enclosure class

The enclosure class is IP 67 when connected using the cable head with a moulded cable. Enclosure class is IP 65 when using the standard cable head for fitting by the user, while the bare valve, with Fast on connectors, has an enclosure class of IP 20.

### Insensitive to dirty air

The use of generously sized flow paths (1.0 mm diameter) means that the valve can be used in normal industrial environments without problems of blocking.

### Manual changeover as standard

The valves incorporate a manual override function, operated by a spring-return or lockable arm.

## Order key, solenoid valves

<b>P 2 E -</b>	<b>Q</b>	<b>V</b>	<b>3</b>	<b>2</b>	<b>C</b>	<b>3</b>
----------------	----------	----------	----------	----------	----------	----------

Valve family	
<b>P2E</b>	Solenoid valves

Subfamily	
Solenoid valve, 15 mm wide Electric connection acc. to DIN 43650, form C EI/supply connection on opposite side	
<b>K</b>	Standard version
<b>M</b>	Mobile version
<b>Q</b>	Food industry version 

Type of current	
<b>1</b>	AC 50 Hz
<b>2</b>	DC
<b>4</b>	AC 50/60 Hz

  

Voltage	
<b>B</b>	12 V
<b>C</b>	24 V
<b>D</b>	48 V
<b>F</b>	115 V
<b>J</b>	230 V

Overrides	
<b>0</b>	Without
<b>1</b>	Non locking ( <b>blue</b> )
<b>2</b>	Locking (yellow)
<b>3</b>	Extended non locking ( <b>blue</b> )
<b>4</b>	Extended locking (yellow)

Valvetype/Function	
<b>3</b>	 3/2 valve (NC)

**Possible combinations**  
See page 28

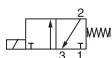
## Technical data

	<b>NC, Standard</b>	<b>NC, Food*</b>	<b>NC, Mobile</b>
Working pressure	0 to 10 bar	0 to 10 bar	0 to 10 bar
Working temperature	-15 °C to +60 °C	-15 °C to +60 °C	-15 °C to +60 °C
Orifice	1,0 mm	1,0 mm	1,0 mm
Flow Qmax	33 NI/min	33 NI/min	22 NI/min
Power, hold	DC 1,2 W / AC 1,6 VA	DC 1,2 W / AC 1,6 VA	DC 1 W
Power, inrush	DC 1,2 W / AC 3,5 VA	DC 1,2 W / AC 3,5 VA	DC 1 W
Connection time	100%	100%	100%
Voltage tolerance	+10%/-15%	+10%/-15%	+25%/-30%
Electric connection:	DIN 43650 form C		
Port pattern:	To future CNOMO standard		
Protection:	IP 65 - IP 67, depending on type of cable head		
Approval:	Some valves are UL-approved and marked with the following symbol 		
Working media:	All neutral media, such as compressed air, water, hydraulic oil and many gases.		
* Design:	Completely smooth exterior, suitable for food industry.		

## Transients

Interrupting the current through the solenoid coil produces momentary voltage peaks which, under unfavourable conditions, can amount to several hundred times the rated operating voltage. Normally, these transients do not cause problems, but to achieve the maximum life of relays in the circuit (and particularly of transistors, thyristors and integrated circuits) it is desirable to provide protection by means of voltage-dependent resistors (VDR). All cable heads having a yellow LED also incorporate such protection.

## Life











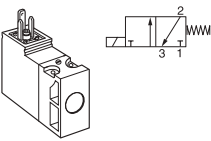











With compressed air at 6 bar, 20 °C and complying with the requirements for compressed air quality as set out in the EU Machine Directive, the valves should have a life of at least 50 million operations.





## Materials

Valve	Thermoplastic
Body, coil casing	Steel
Internal metal parts	Stainless steel
Screws	Thermoplastic
Bottom plug	FPM (Viton™) and nitrile rubber
Sealing materials	
Cable head	
Sheath	Thermoplastic
Retaining screw	Stainless steel

## Solenoids 15 mm NC, standard

(Note! mounting screws included in basic valve P2V-A/B...)

Voltage	Weight Kg	Order code		Weight Kg	Order code		
		Without manual override			Override, blue, non locking flush	Override, yellow, locking flush	
	12 VDC	0,038	<b>P2E-KV32B0</b> 	0,038	<b>P2E-KV32B1</b> 	0,038	<b>P2E-KV32B2</b> 
	24 VDC	0,038	<b>P2E-KV32C0</b> 	0,038	<b>P2E-KV32C1</b> 	0,038	<b>P2E-KV32C2</b> 
	48 VDC	0,038	<b>P2E-KV32D0</b> 	0,038	<b>P2E-KV32D1</b> 	0,038	<b>P2E-KV32D2</b> 
	24 VAC 50Hz	0,038	<b>P2E-KV31C0</b> 	0,038	<b>P2E-KV31C1</b> 	0,038	<b>P2E-KV31C2</b> 
	48 VAC 50/60Hz	0,038	<b>P2E-KV34D0</b> 	0,038	<b>P2E-KV34D1</b> 	0,038	<b>P2E-KV34D2</b> 
	115 VAC 50Hz/	0,038	<b>P2E-KV31F0</b> 	0,038	<b>P2E-KV31F1</b> 	0,038	<b>P2E-KV31F2</b> 
	120 VAC 60Hz						
	230 VAC 50Hz/	0,038	<b>P2E-KV31J0</b> 	0,038	<b>P2E-KV31J1</b> 	0,038	<b>P2E-KV31J2</b> 
	240 VAC 60Hz						

Voltage	Weight Kg	Order code	Weight Kg	Order code
		Override, extended non locking flush, blue		Override, extended locking flush, yellow
24 VDC	0,038	<b>P2E-KV32C3</b> 	0,038	<b>P2E-KV32C4</b> 
24 VAC 50Hz	0,038	<b>P2E-KV31C3</b> 	0,038	<b>P2E-KV31C4</b> 





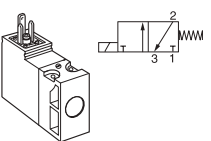





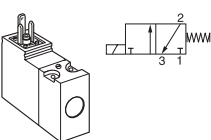







## Solenoid 15 mm NC, mobile









(Note! mounting screws included in basic valve P2V-A/B...)

Voltage	Weight Kg	Order code	Weight Kg	Order code
		Without manual override		Override, blue, non locking flush
	12 VDC	0,038	<b>P2E-MV32B0</b>	<b>P2E-MV32B1</b>
	24 VDC	0,038	<b>P2E-MV32C0</b>	<b>P2E-MV32C1</b>

## Solenoid 15 mm NC, food industry version

(Note! mounting screws included in basic valve P2V-A/B...)

Voltage	Weight Kg	Order code		Weight Kg	Order code		
		Without manual override			Override, blue, non locking flush	Override, yellow, locking flush	
	24 VDC	0,038	<b>P2E-QV32C0</b> 	0,038	<b>P2E-QV32C1</b> 	0,038	<b>P2E-QV32C2</b> 
	24 VAC 50Hz	0,038	<b>P2E-QV31C0</b> 	0,038	<b>P2E-QV31C1</b> 	0,038	<b>P2E-QV31C2</b> 
	48 VDC	0,038	<b>P2E-QV32D0</b> 	0,038	<b>P2E-QV32D1</b> 	0,038	<b>P2E-QV32D2</b> 
	48 VAC 50/60Hz	0,038	<b>P2E-QV34D0</b> 	0,038	<b>P2E-QV34D1</b> 	0,038	<b>P2E-QV34D2</b> 
	115 V 50Hz/	0,038	<b>P2E-QV31F0</b> 	0,038	<b>P2E-QV31F1</b> 	0,038	<b>P2E-QV31F2</b> 
	120 V 60Hz						
	230 VAC 50Hz/	0,038	<b>P2E-QV31J0</b> 	0,038	<b>P2E-QV31J1</b> 	0,038	<b>P2E-QV31J2</b> 
	240 VAC 60Hz						



Voltage	Weight Kg	Order code	Weight Kg	Order code
		Override, extended non locking flush, blue		Override, extended locking flush, yellow
24 VDC	0,038	<b>P2E-QV32C3</b> 	0,038	<b>P2E-QV32C4</b> 
24 VAC 50Hz	0,038	<b>P2E-QV31C3</b> 	0,038	<b>P2E-QV31C4</b> 
115 VAC 50 Hz	0,038	<b>P2E-QV31F3</b> 	0,038	<b>P2E-QV31F4</b> 
230 VAC 50 Hz	0,038	<b>P2E-QV31J3</b> 	0,038	<b>P2E-QV31J4</b> 



In accordance with the EU Machine Directive, EN 983, solenoid valves with manual override should have spring-return operating arms for safety.

 = UL-approved

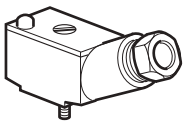
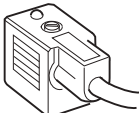
## Cable plugs DIN 43650, form C (Cable plug with cable and round connector see page 32)

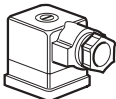
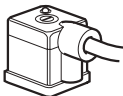
	Description	Weight kg	Order code
	Electrical connection through top cover Stainless steel screw	Standard IP 65	0.02 <b>P8C-H</b>
		24 VAC/DC VDR + LED + REC IP65*	0.02 <b>P8C-H36C</b>
		24 VAC/DC VDR + LED IP65	0.02 <b>P8C-H26C</b>
		110-120 VAC/DC VDR + LED IP65	0.02 <b>P8C-H21E</b>
		220-240 VAC/DC VDR + LED IP65	0.02 <b>P8C-H21G</b>
	With cable and stainless steel screw	24 VAC/DC VDR + LED + REC, 2 m cable PVC IP67*	0.13 <b>P8L-H236C</b>
		24 VAC/DC VDR + LED + REC, 10 m cable PVC IP67*	0.58 <b>P8L-HA36C</b>
	With large headed screw suitable for mounting in inaccessible or recess position	Standard IP 65	0,02 <b>P8C-C</b>
		24 VDC VDR+ LED IP65	0,02 <b>P8C-C26C</b>
		110 VAC VDR + LED IP65	0,02 <b>P8C-C21E</b>
	With standard screw	Standard IP 65	0,02 <b>P8C-D</b>
		24 VDC VDR+ LED IP65	0,02 <b>P8C-D26C</b>
		110 VAC VDR + LED IP65	0,02 <b>P8C-D21E</b>
	With cable	Standard with 2 m cable IP 65	0,13 <b>P8L-C2</b>
		Standard with 5 m cable IP 65	0,30 <b>P8L-C5</b>
		24 VAC/DC, 2 m cable VDR + LED IP65	0,13 <b>P8L-C226C</b>
		24 VAC/DC, 5 m cable VDR + LED IP65	0,30 <b>P8L-C526C</b>
		24 VAC/DC, 10 m cable VDR + LED IP65	0,58 <b>P8L-CA26C</b>
		110 VAC/DC, 2 m cable VDR + LED IP65	0,13 <b>P8L-C221E</b>
		110 VAC/DC, 5 m cable VDR + LED IP65	0,30 <b>P8L-C521E</b>

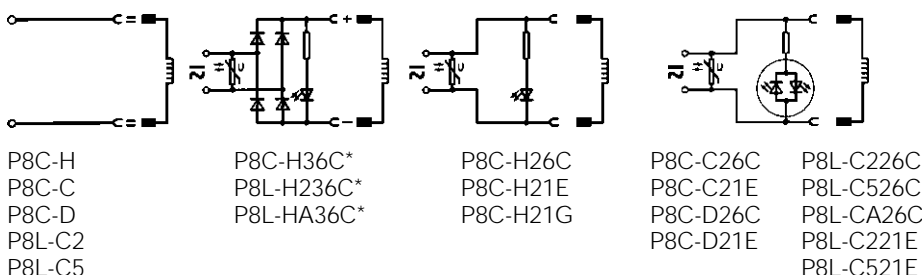

**\* NB!**  
*The cable plug with integral rectifier (REC) can be used for both AC and DC supplies to valves intended for DC operation.*

## Spare mounting screws (package of 10)

Type	Material	Ø mm	Length mm	Weight Kg	Order code
	Self tapping	Stainless steel	3	26	0,04 <b>P2E-KD027SS3</b>

## Dimensions

### Solenoid valves P2E-V...

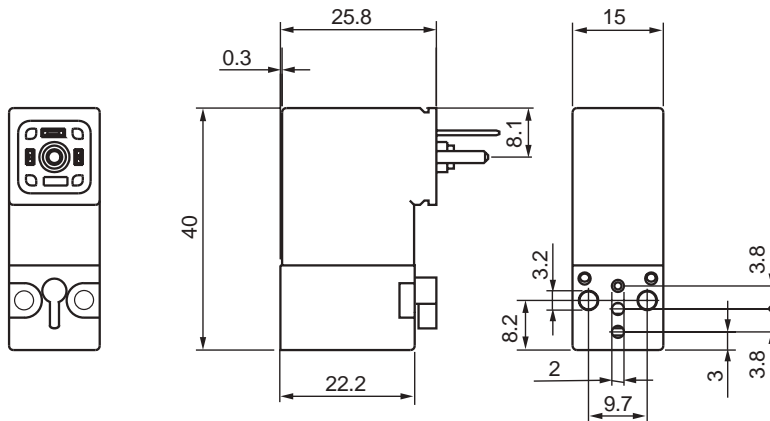

### Cable heads

- P8C-H
- P8C-H36C
- P8C-H26C
- P8C-H21E
- P8C-H21G

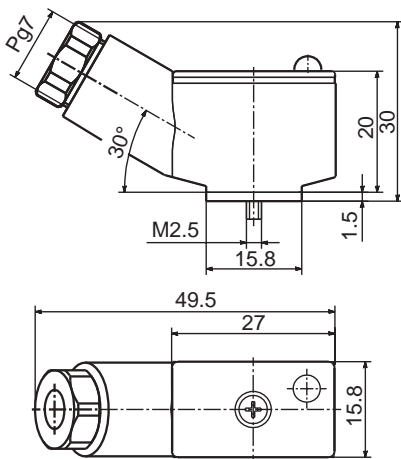

### Cable heads

- P8L-H236C
- P8L-HA36C

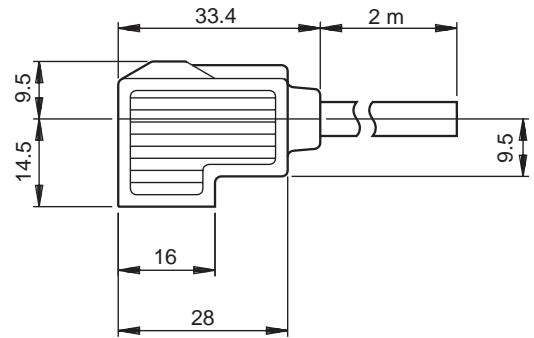
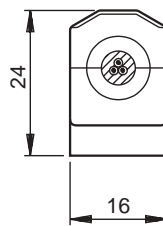

### Cable heads

- P8C-C
- P8C-C26C
- P8C-C21E
- P8C-D
- P8C-D26C
- P8C-D21E

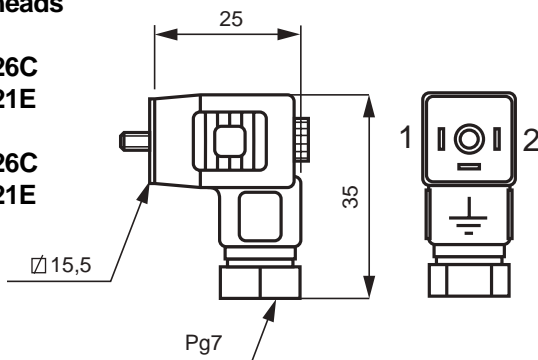

### Cable heads

- P8C-C2
- P8C-C5
- P8C-C226C
- P8C-C526C
- P8C-CA26C
- P8C-C221E
- P8C-C521E

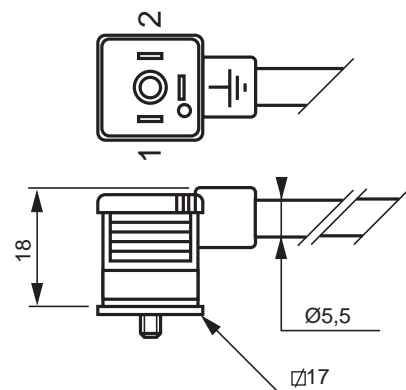

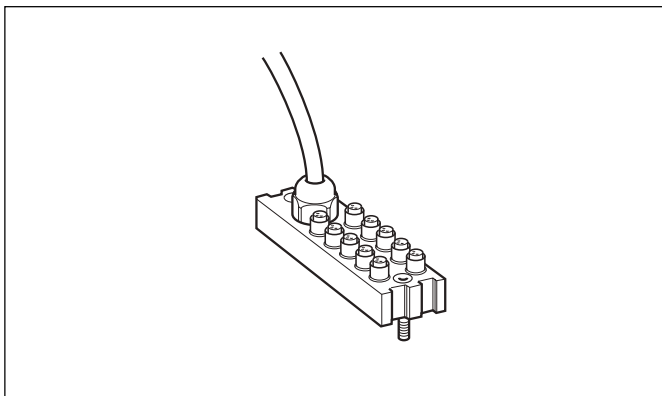

### Technical data, Valvetronic 110

#### Connections:

Ten 3-pole numbered 8 mm round snap-in female contacts

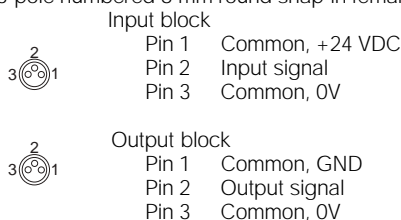

**Note!**  
When using reed contact, a special adapter cable has to be used. Order code 9121717030.

### The Valvetronic 110 connection block

The Valvetronic 110 is a connection block that can be used for collecting signals from sensors at various points on a machine and connecting them to the control system via a multicore cable. It can also be used as a central point for connecting a multicore cable to the outputs of a control system, to provide a common point from where the output signals can be connected. The block has ten 8 mm snap-in round contacts and a 3 or 10 m multicore cable. The connections on the block are numbered from 1 to 10. Blanking plugs are available for unused connections, as labels for marking the connections of each block.

#### Mechanical data

Enclosure IP 67, DIN 40050 with fitted contacts and/or blanking plugs.  
Temperature -20 to +70 °C

#### Material

Body PA 6,6 VD according to UL 94  
Contact holder PBTP  
Snap-in ring LDPE  
Moulding mass Epoxy  
Seal NBR  
Screws Plated steel

#### Cable:

Length 3 m or 10 m  
Type of cable LifYY11Y  
Conductor 12  
Area 0.34 mm<sup>2</sup>  
Colour marking According to DIN 47 100

#### Electrical data:

Voltage 24 VDC (max. 60 V AC/75 V DC)  
Insulation group according to DIN 0110 class C  
Load max. 1 A per connection  
total max. 3 A

### Valvetronic 110

Designation	Order code	Weight kg
Valvetronic 110 with 3 m cable	9121719001	0,32
Valvetronic 110 with 10 m cable	9121719002	0,95
Blanking plugs (pack of 10)	9121719003	0,02
Labels (pack of 10)	9121719004	0,02

#### Industrial durability

Good chemical and oil resistance. Tests should be performed in aggressive environments.



Use **blanking plugs** to close unused connections.



Use **White labels** to insert in grooves on the side of the connection

### Dimensions and wiring diagrams

Conductor	Colour	Input	Output
1	Pink	Signal 1	Signal 1
2	Grey	Signal 2	Signal 2
3	Yellow	Signal 3	Signal 3
4	Green	Signal 4	Signal 4
5	White	Signal 5	Signal 5
6	Red	Signal 6	Signal 6
7	Black	Signal 7	Signal 7
8	Violet	Signal 8	Signal 8
9	Grey-Pink	Signal 9	Signal 9
10	Red-Blue	Signal 10	Signal 10
A	Blue	0 V	0 V
B	Brown	+24 V	PE

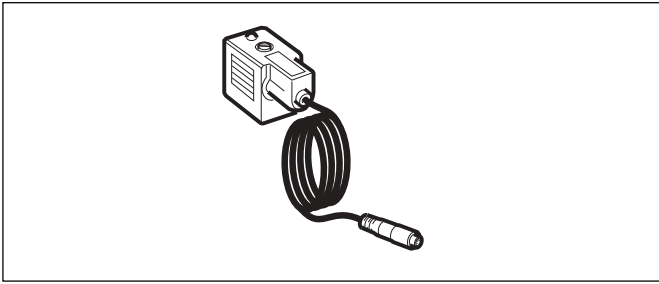

**Technical data**

Voltage	24 VDC
Indication	LED, yellow
Transient protection	VDR
Load, max.	4 A
Enclosure	IP65

**Pre-wired solenoid connector**

Cable head with a moulded cable and 8 mm snap-in round contact for connection of conventional solenoid valves to the Valvetronic system. The cable head incorporates an LED for status indication and a surge suppressor. When need for longer cables arise, use extension cables below.

**Cable head according to DIN 43650**

Designation	Order code	Weight kg
-------------	------------	--------------

**Form C**

Length of cable 0,3 m  
Length of cable 0,6 m



<b>9121719035</b>	0,07
<b>9121719036</b>	0,09

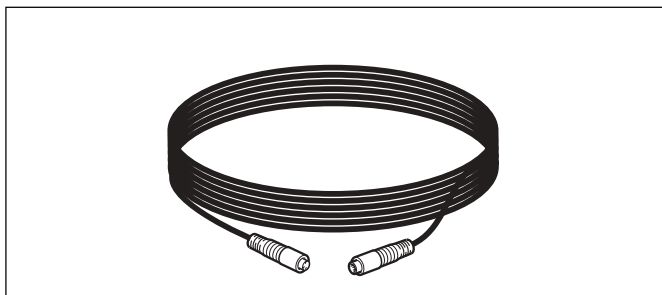
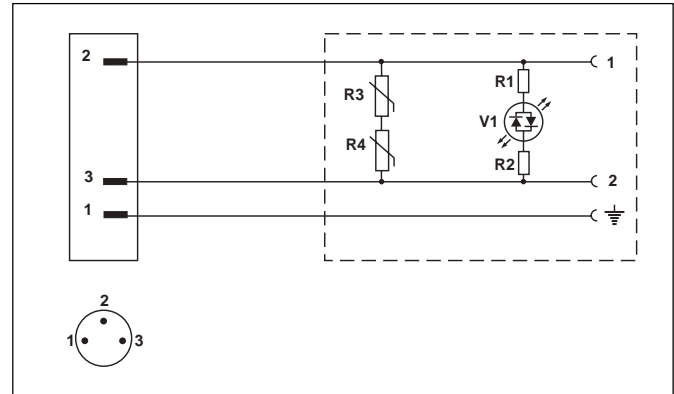

**Technical data**

**Contacts**

Mould-fitted 8 mm snap-in male/female contacts.  
Enclosure IP67

**Cable**

Conductor 3x0,25 mm<sup>2</sup> (32x0,10 mm<sup>2</sup>)  
Sheath PVC/PUR  
Colour Black

**Ready-to-use cables**

Cables with mould-fitted 8 mm snap-in round contacts in both ends. The cables are available in two types, one with a straight male and female connectors respectively., and one with a straight 3-pole male connector in one end and an angled 3-pole female connector in the other end.

Cables with mould-fitted 8 mm snap-in round contacts in both ends, straight male and female connectors respectively.

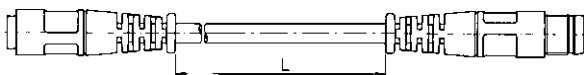

Cables with a straight 3-pole male connector in one end and an angled 3-pole female connector in the other end.

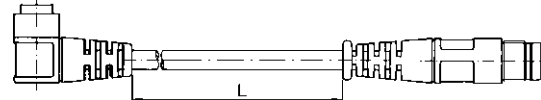

Designation	Order code	Weight kg
Cable with straight contacts, 0,2 m	<b>9121717014</b>	0,02
Cable with straight contacts, 0,3 m	<b>9121717015</b>	0,02
Cable with straight contacts, 0,5 m	<b>9121717016</b>	0,03
Cable with straight contacts, 1,0 m	<b>9121717017</b>	0,03
Cable with straight contacts, 2,0 m	<b>9121717018</b>	0,05
Cable with straight contacts, 3,0 m	<b>9121717019</b>	0,07
Cable with straight contacts, 5,0 m	<b>9121717020</b>	0,12
Cable with straight contacts, 10 m	<b>9121717021</b>	0,23

Designation	Order code	Weight kg
Cable with:		
straight and angled connectors, 0,2 m	<b>9121717022</b>	0,02
straight and angled connectors, 0,3 m	<b>9121717023</b>	0,02
straight and angled connectors, 0,5 m	<b>9121717024</b>	0,03
straight and angled connectors, 1,0 m	<b>9121717025</b>	0,03
straight and angled connectors, 2,0 m	<b>9121717026</b>	0,05
straight and angled connectors, 3,0 m	<b>9121717027</b>	0,07
straight and angled connectors, 5,0 m	<b>9121717028</b>	0,12
straight and angled connectors, 10 m	<b>9121717029</b>	0,23



## Plug assembly instruction

The multiple manifolds can be programmed for different functions with help of the plugs.

### P2V-A

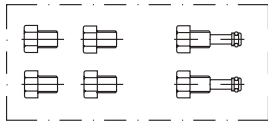

P2V-AV•00P•  
P2V-AV•00Q•

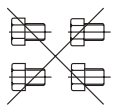
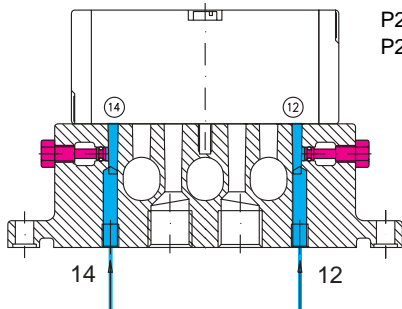

Air actuated valves

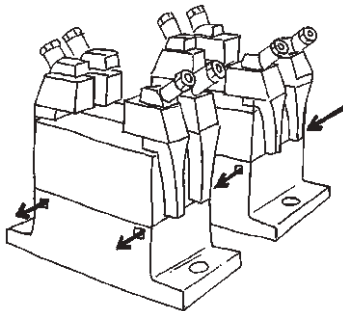

P2V-AV500E•  
P2V-AV600E•  
P2V-AV700E•  
P2V-AV800E•  
P2V-AV500J•

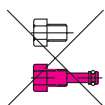
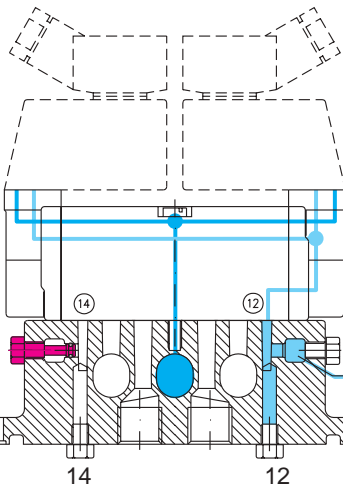

Electrical actuated valves with internal air supply to the solenoid(s).

### P2V-B

P2V-BV•00P•  
P2V-BV•00Q•

P2V-AVN00E•  
P2V-APV00E•  
P2V-AVQ00E•  
P2V-AVR00E•  
P2V-AVN00J•

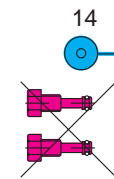

Electrical actuated valves with external air supply to the solenoid(s).

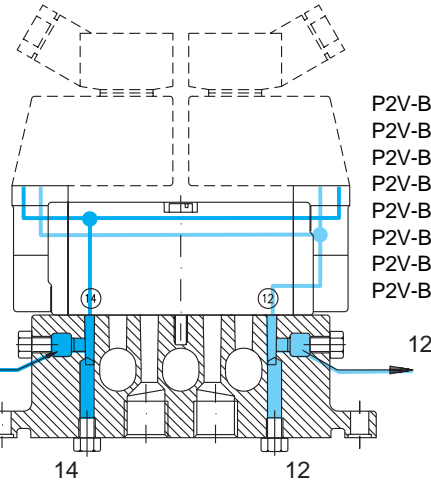

P2V-BVN00E•  
P2V-BVP00E•  
P2V-BVQ00E•  
P2V-BVR00E•  
P2V-BVN00J•  
P2V-BVP00J•  
P2V-BVQ00J•  
P2V-BVR00J•

P2V-AVN00E•  
P2V-APV00E•  
P2V-AVQ00E•  
P2V-AVR00E•  
P2V-AVN00J•

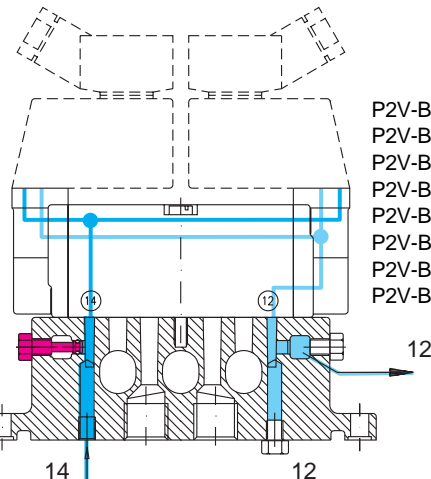
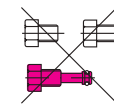

P2V-BVN00E•  
P2V-BVP00E•  
P2V-BVQ00E•  
P2V-BVR00E•  
P2V-BVN00J•  
P2V-BVP00J•  
P2V-BVQ00J•  
P2V-BVR00J•

Electrical actuated valves with individual external air supply to the solenoid(s).

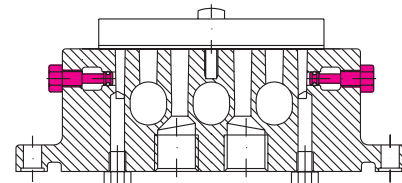
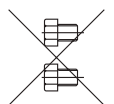

Blanking plate





## ***Pneumatic Division Sales Offices***

---

**Austria - Wr.Neustadt**  
Tel: +43 2622 23501-970  
Fax: +43 2622 23501-977

**Belgium - Nivelles**  
Tel: +32 67 280 900  
Fax: +32 67 280 999

**Czech and Slovak  
Republics - Prague**  
Tel: +4202 830 852 24  
Fax: +4202 830 853 60

**Ballerup - Denmark**  
Tel: +45 43 560 400  
Fax: +45 43 733 107

**Finland - Vantaa**  
Tel: +358 9 4767 31  
Fax: +358 9 4767 3201

**France - Evreux**  
Tel: +33 820 825 239  
Fax: +33 820 029 870

**Germany - Mettmann**  
Tel: +49 2104 137 0  
Fax: +49 2104 137 500

**Greece - Athens**  
Tel: +30 210 933 6450  
Fax: +30 210 933 6451

**Hungary - Budapest**  
Tel: +36 1 220 4155  
Fax: +36 1 422 1525

**Italy - Corsico, Milan**  
Tel: +39 02 4519 21  
Fax: +39 02 4479 340

**Netherlands - Oldenzaal**  
Tel: +31 541 585 000  
Fax: +31 541 585 459

**Norway - Langhus**  
Tel: +47 6491 1000  
Fax: +47 6491 1090

**Poland - Warsaw**  
Tel: +48 22 8634 942  
Fax: +48 22 8634 944

**Portugal - Leça da  
Palmeira**  
Tel: +351 22 999 7360  
Fax: +351 22 996 1527

**Romania - Bucharest**  
Tel: +40 21 252 3382  
Fax: +40 21 252 3381

**Russia - Moscow**  
Tel: +7 095 234 0054  
Fax: +7 095 234 0528

**Slovenia - Novo mesto**  
Tel: +386 7337 6650  
Fax: +386 7337 6651

**Spain - Madrid**  
Tel: +34 91 675 7300  
Fax: +34 91 675 7711

**Sweden - Spånga**  
Tel: +46 (0) 8 5979 5000  
Fax: +46 (0) 8 5979 5110

**Switzerland - Beil**  
Tel: +41 32 3653 711  
Fax: +41 32 3653 730

**UK - Cannock**  
Tel: +44 1543 456 000  
Fax: +44 1543 456 001

**Ukraine - Kiev**  
Tel: +380 44 220 7432  
Fax: +380 44 220 6534



**Parker Hannifin plc**  
Pneumatic Division  
Walkmill Lane, Bridgtown,  
Cannock, Staffs. WS11 0LR. U.K.

We reserve the right to make  
alterations without prior notification.  
Edition 07.04